

Venus GX (VGX) manual

1. Introduction

1.1 Description

In many ways the **Venus GX (VGX)** and the **Color Control GX (CCGX)** are the same device. They share a lot of hardware, and they run on identical software - our 'Venus OS' - therefore firmware numbering is the same; and new version releases always apply to both devices at the same time.

As many of the functions of the two devices are identical, the [CCGX Manual](#) should also be consulted if something is not specifically covered in this VGX manual.

This manual refers to the latest firmware version. A device connected to the internet will perform new-version updates automatically. Check the latest firmware version [here](#).

Venus GX/CCGX comparison table

See the [Victron GX product range](#) page.

1.2 What's in the Box?

- Venus GX (VGX)
- VE.Can terminator (2 pcs).
- Power cable with inline fuse and M8 terminal eyes for battery- or DC busbar-attachment.
- Terminal Blocks for all the connectors on each side.
- Label showing WiFi key and product details.



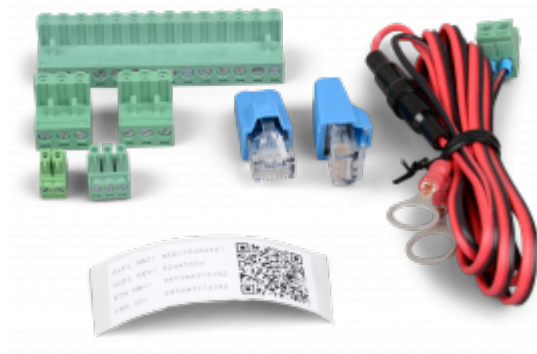

1.3 Overview of connections

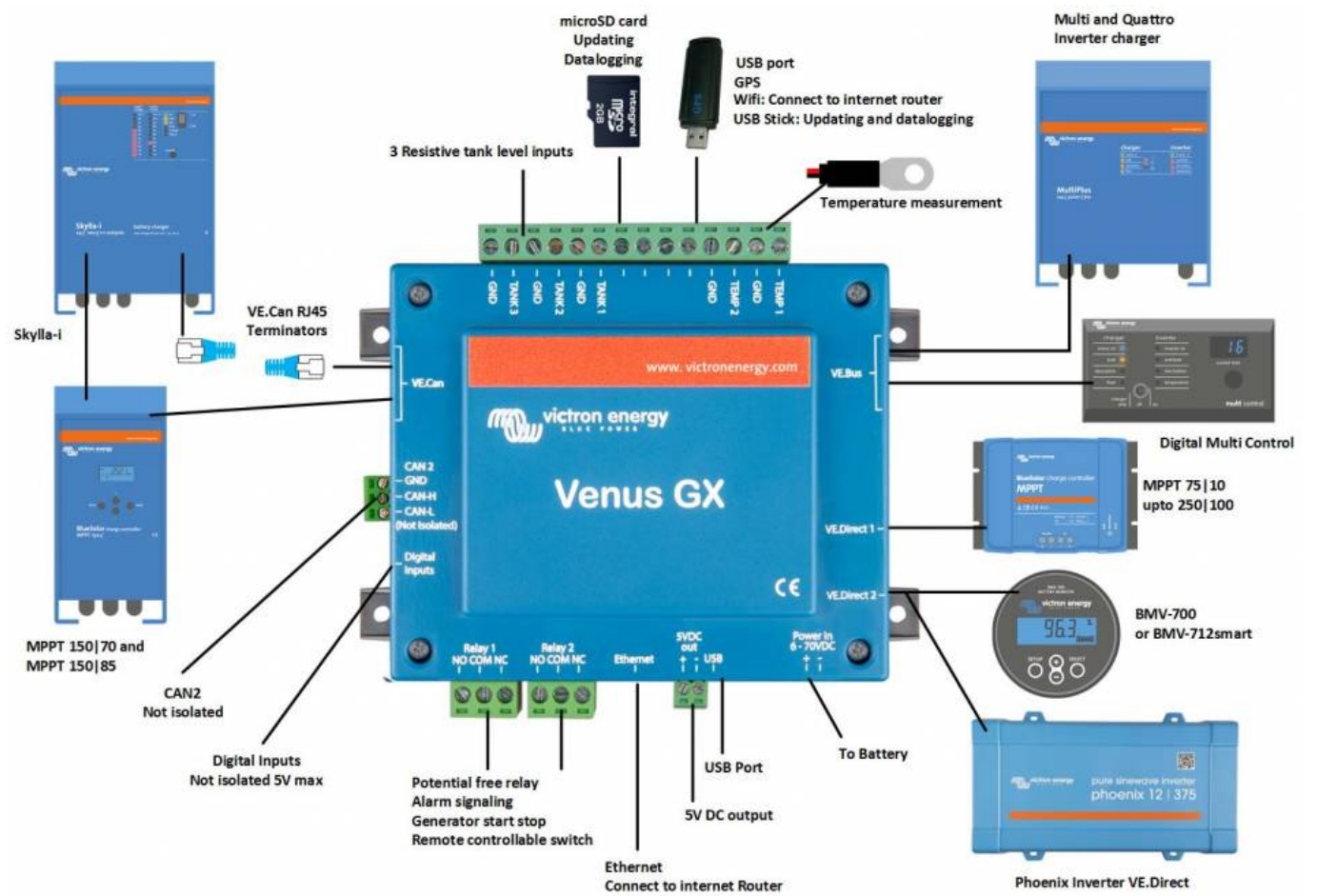

2. Accessing the device

Because the Venus GX has no visual display or buttons, you need either a smartphone, tablet or laptop to access it.

This access is called Remote Console. There are three ways to access the Remote Console:

1. Through the online VRM Portal, which requires internet, see chapter 2.1;
2. By using the built-in WiFi Access Point, see chapter 2.2;
3. Or, via the local LAN/WiFi network; see chapter 2.3.

2.1 Accessing via VRM

This method requires a working internet connection, both on your phone/tablet/laptop as well as for the Venus GX. For a new install, this means that it needs to be connected by Ethernet cable.

Step by step instructions:

First, connect the Venus GX to the internet by plugging it into a working Ethernet network which has a DHCP server, as most networks do, and which is connected to the internet. The Venus GX will immediately connect to VRM.

Now, go to the VRM Portal, <https://vrm.victronenergy.com/>, and follow the instructions to add the device. More information about this is available in the [VRM Manual](#).

Then once visible on VRM, click the 'Remote Console' link to open the window. Which will look like below screenshot.

More information about 'Remote Console' on VRM is explained in the [CCGX Manual](#), [VRM Remote Console chapter](#).

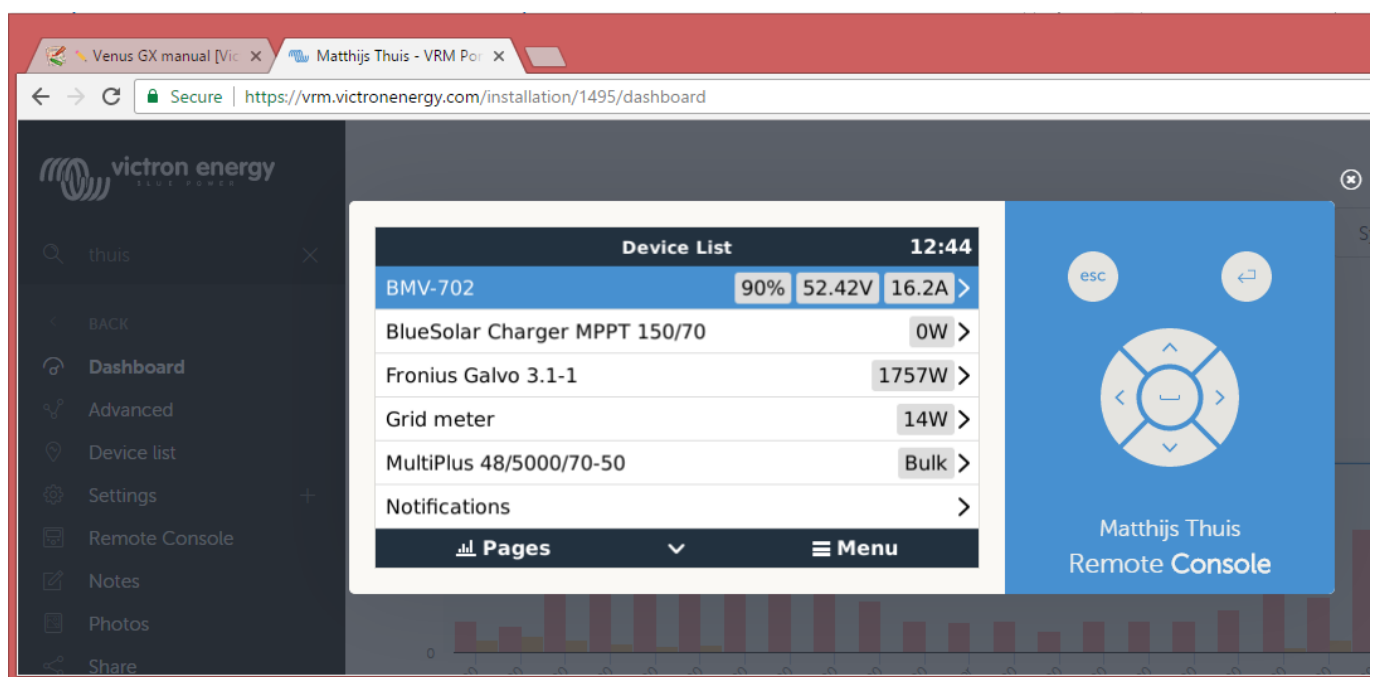

2.2 Accessing via the built-in WiFi Access Point

This method requires the [VictronConnect App](#) to be installed on your smartphone, tablet or laptop.

Steps:

1. Make sure you are no further than a few metres away from the Venus GX
2. Go to the WiFi settings on your phone / tablet / laptop.
3. After searching, the Venus GX will show up in the list, as Venus -HQ1940DEFR4 - 3b6. Where HQ... is the serial number as printed on the side of the box.
4. Connect to WiFi using the 'WiFi key' which you will find printed on the side of the box ...and also on a card in the plastic bag. Keep that in a safe place.

5. Open VictronConnect, it will start scanning the WiFi network automatically.
6. Once found, select the GX device from the list.
7. Open the Remote Console

Notes:

- If you cannot use VictronConnect, you can use a web browser and navigate to the IP address 172.24.24.1
- For added security it is possible to disable the WiFi Access Point. See Settings → Wi-Fi → Create access point. See below chapter explaining the Push button for how to restore access in case ever necessary.

Instruction video

Step by step instruction video on how to connect to a GX device using the [VictronConnect App](#).



Video

Detailed instruction video

This second video was made before VictronConnect got the feature to find a device on a network. All the explanations in the video regarding IP Addressing can be ignored, and use VictronConnect as in above video instead.



Video

2.3 Accessing via the local LAN/WiFi Network

2.3.1 Introduction and common installations

This section explains how to connected to Remote Console when the Venus GX is connected to the local computer network, with either an Ethernet cable, or having it configured to connect to a local WiFi network.

This method does not require an internet connection. Just a local computer network is sufficient.

Once connected, connect to the GX Device by running the [VictronConnect App](#) on a phone, tablet or laptop. Note that will need to be connected to the same computer network as the Venus GX.

This video shows how its done:



Video

2.3.2 Alternative methods to find the IP Address

In case VictronConnect can't be used, here are a few other methods to find the Venus GX, ie. its IP Address.

IP Address on VRM

On the VRM Portal, you'll find the IP address on the Device List page of the installation. Note that this does require the Venus GX to be connected to the internet.

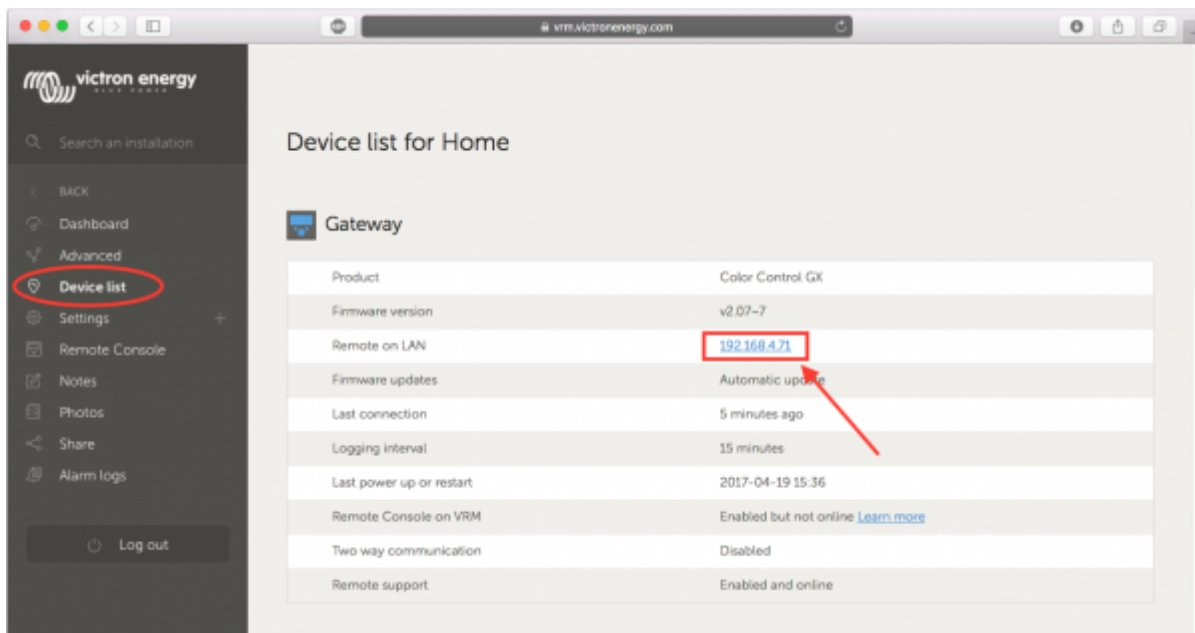

Network (on Microsoft Windows)

In a local network, for example at home, you can also find the Venus GX in the Windows 'Network' overview:

Double-clicking the icon will open up Remote Console on LAN.

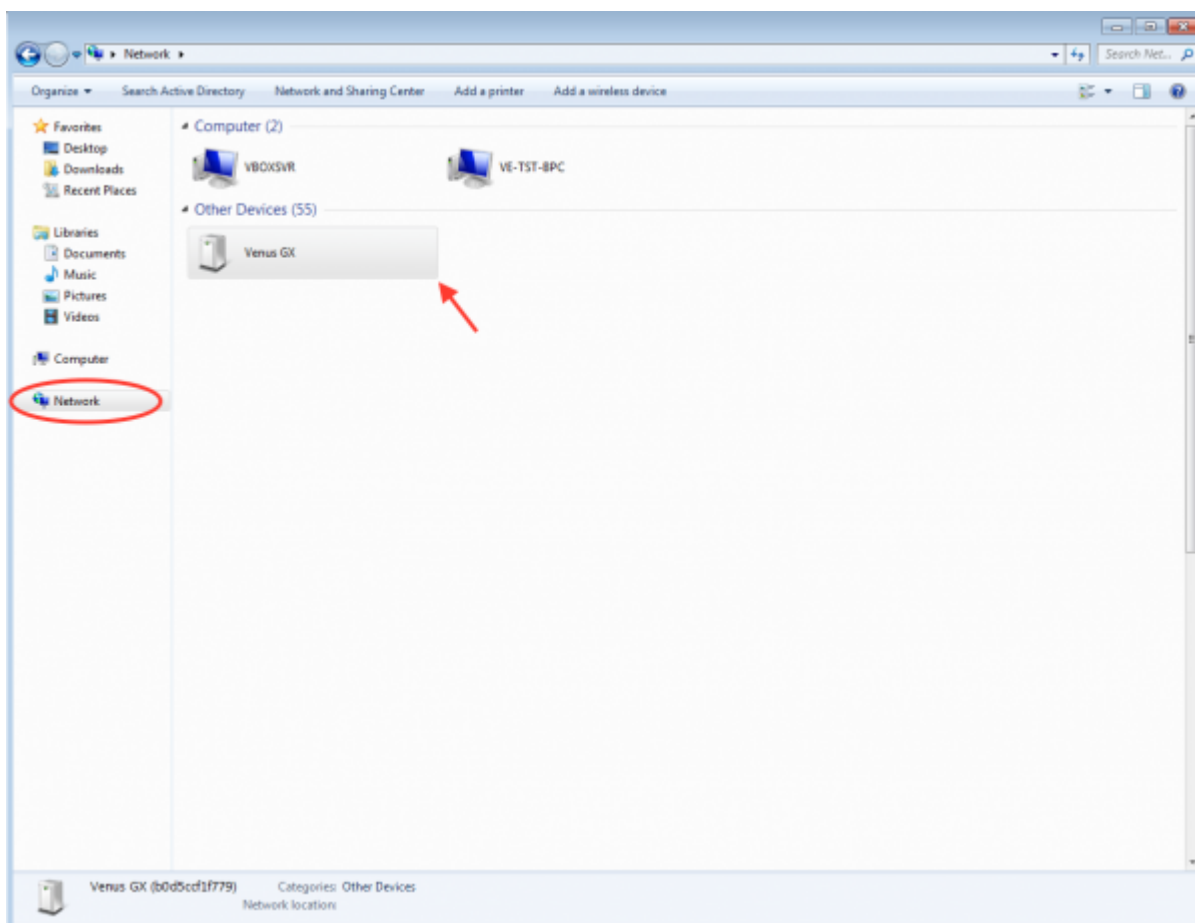

Open the 'Properties' window to see the IP address.

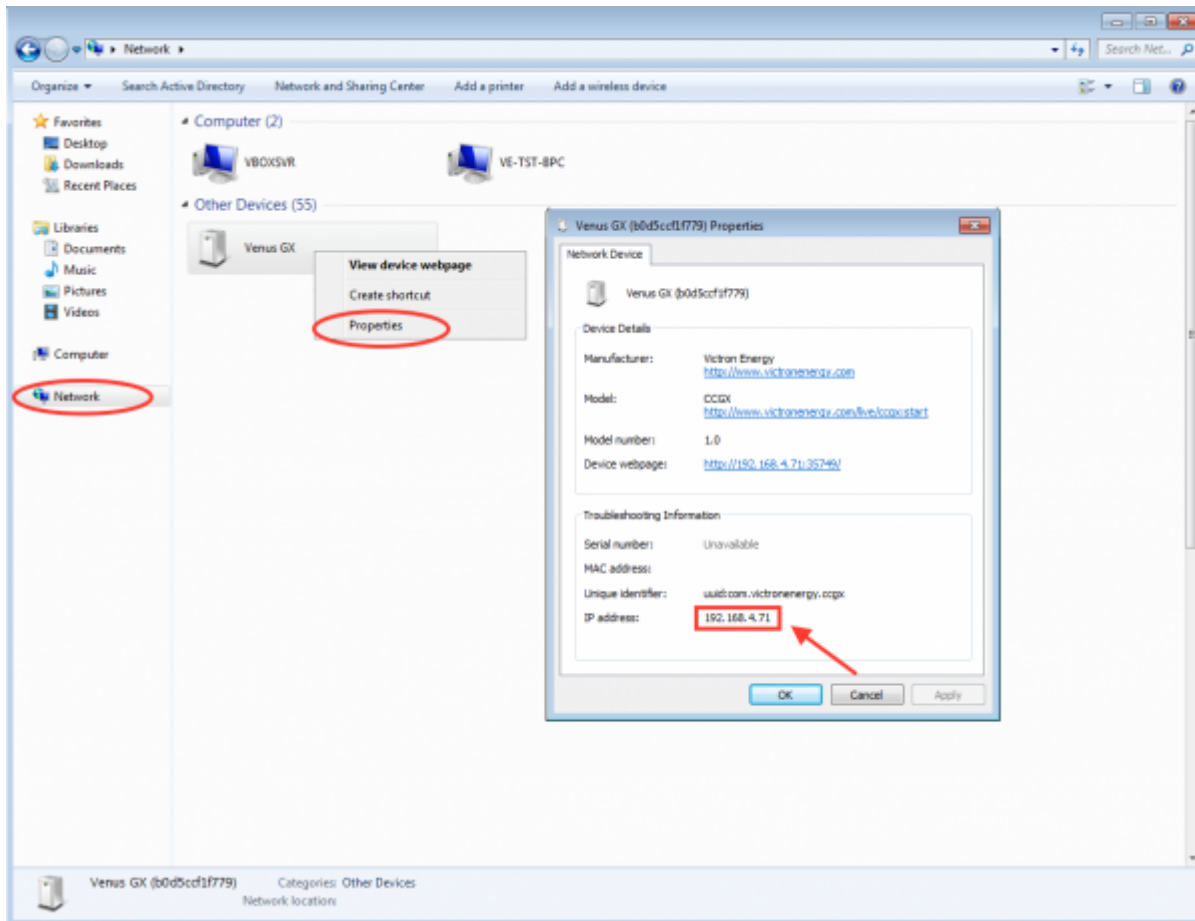

This uses Universal plug-and-play broadcast technology.

3. LEDs and Push-button

3.1 LEDs

Boot-up

On the side of the Venus GX, there is a LED. During power-up it it goes through these states:

- Stage 1: Both green and red illuminate briefly and faintly (it's hard to see the green) for approximately 1 second.
- Stage 2: Red illuminates for approximately 1 second.
- Stage 3: Green illuminates for approximately 0.5 seconds.
- Stage 4: Both green and red illuminate briefly and faintly (it's hard to see the green) for approximately 1 second.

During operation

- Slow blinking: built-in WiFi access point disabled
- Fast blinking: built-in WiFi access point enabled (default)

Slow blinking is once per second. Fast blinking is twice per second.

3.2 Small button located to the right of the green 14-Terminal Connector Block

Short press: WiFi Access point on/off

A single short press toggles the internal WiFi access point on and off. The LED indicates its state: when the LED blinks green slow, then the built-in Access Point is disabled. when the LED is green and blinking fast, then the built-in Access Point is enabled.

Long press: reset all network settings to factory defaults

Press and hold the small button for a minimum of four seconds. The LED will stay on for 2 seconds to indicate that the long press has been recognised; then release the button again.

- Ethernet is set back to DHCP
- WiFi Access Point is enabled
- Remote Console password is disabled
- Remote Console on LAN and on VRM is enabled

The same button is available on the Octo GX, button is marked SD_BOOT and available under the lid at the top.

4. Digital Inputs

The Venus GX has five digital inputs. The channels are accessible via the RJ-12 socket on the side. This is available for self-wiring by the user/installer.

4.1. Wiring details

The inputs are non-isolated. They operate at 3V3 levels, and can withstand up to 5V input. Each input has an internal 10k pull-up resistor to 3V3. We recommend wiring it to a potential free relay or otherwise open collector/optocoupler output.

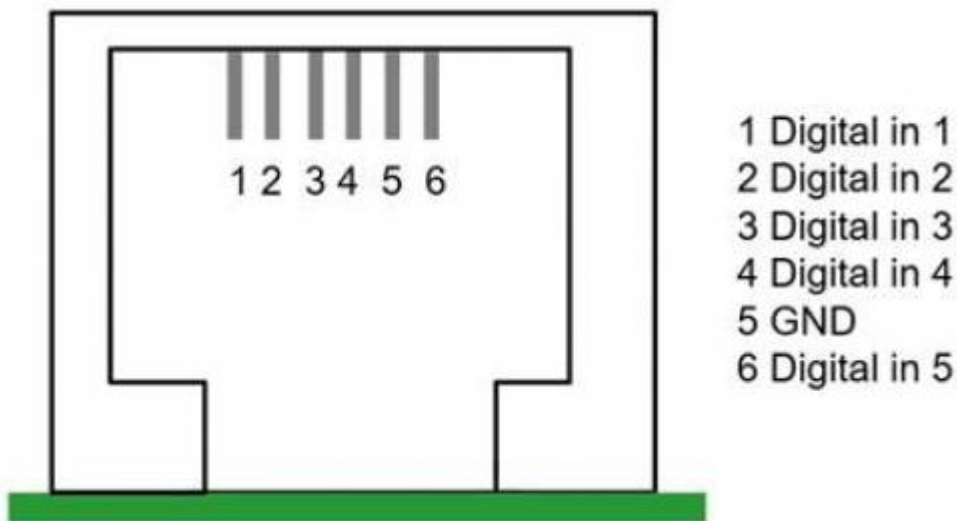

RJ12 pinout	Input
pin1	input1
pin2	input2
pin3	input3
pin4	input4
pin5	gnd
pin6	input5

4.2. Configuration

Each of the digital inputs can be configured as a pulse meter, or as one of a number of predefined sensors that can also be configured as alarms.

The possible configurable functions are:

Function	States
Pulse meter	N/A
Door alarm	Open/Closed
Bilge pump	On/Off
Bilge alarm	Ok/Alarm
Burglar alarm	Ok/Alarm
Smoke alarm	Ok/Alarm
Fire alarm	Ok/Alarm
CO2 alarm	Ok/Alarm
Generator	Running/Stopped

The function of each input can be configured in the GUI under Settings → I/O → Digital Inputs.

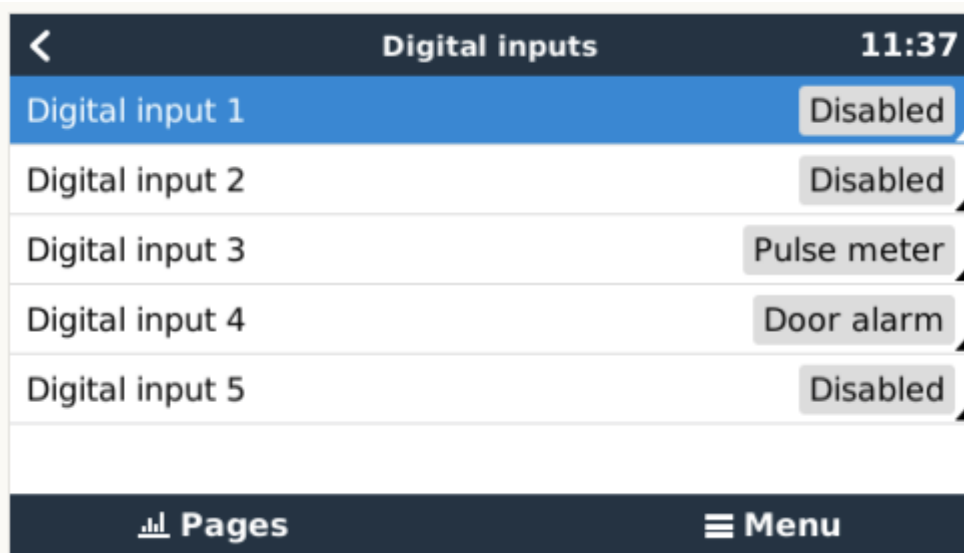

Once the input is configured for its intended purpose, it will show up with other devices.

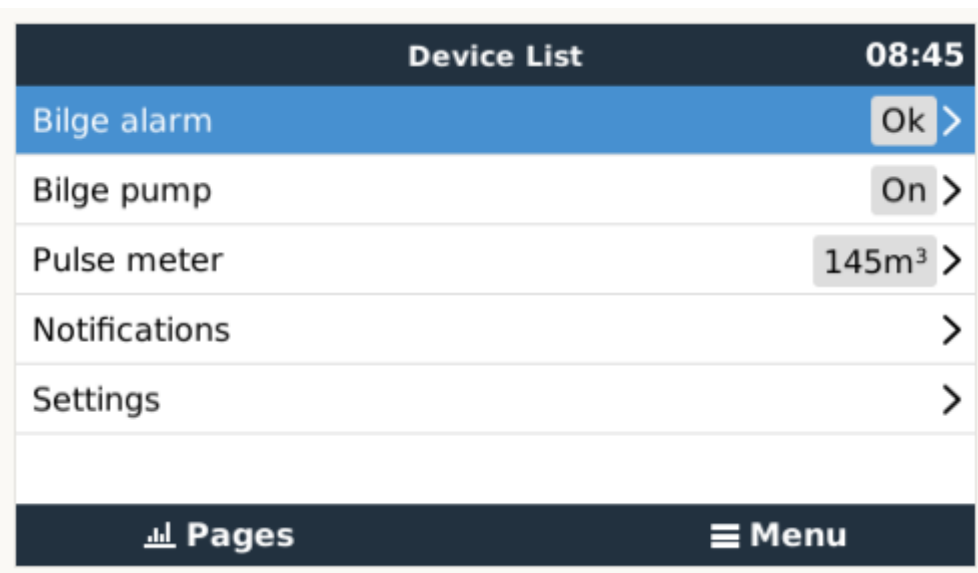

Other parameters related to that function can be configured by entering the device menu and selecting Setup. For pulse meters, you can configure the unit, the multiplier (the volume represented by each pulse) and reset the counter.

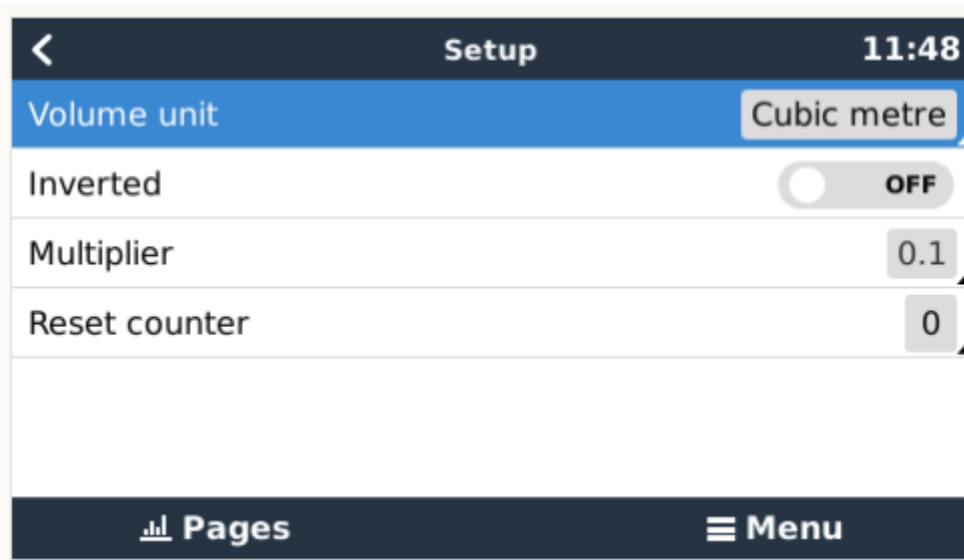

For other sensors and alarms, you can decide whether the input should be treated as an alarm condition, whether the labels should be inverted, and whether the logical levels should be inverted.

- To swap the labels attached to the alarm, set *Inverted* to on.
- If a logical low input (0V) should be considered a positive condition, set *Inverted alarm logic* to on.

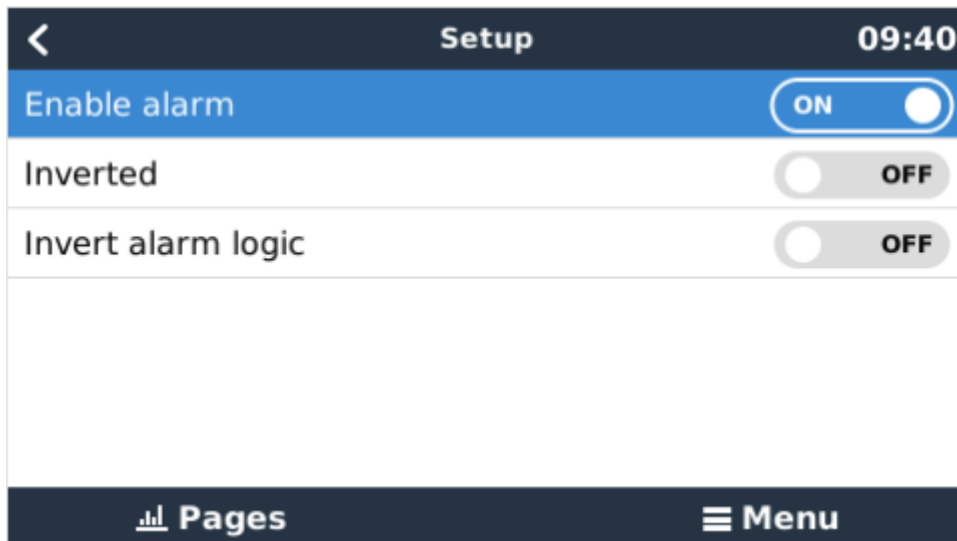

4.3. Read-out of digital inputs via Modbus-TCP

The values/states of the digital inputs are available on Modbus-TCP. For more details about this, please download a copy of the document “Modbus-TCP register list” from our website. And see [our Modbus-TCP FAQ](#).

5. Factory reset

See above chapter 3.2 on the push button.

6. More information

- [ccgx](#)
- [generator_start_stop](#)
- [CCGX Frequently asked questions](#)
- [How to update a GX device](#)
- [CCGX Remote VEConfigure and remote firmware updates](#)
- [VRM Portal](#)
- [VRM Portal - trouble shooting Remote Console](#)
- [Open source](#)

DISQUS

~~DISQUS~~

From:

<https://www.victronenergy.com/live/> - **Victron Energy**

Permanent link:

<https://www.victronenergy.com/live/venus-gx:start?rev=1578345998>

Last update: **2020-01-06 22:26**

