

Venus GX (VGX) manual

In many ways the **Venus GX (VGX)** and the **Color Control GX (CCGX)** are the same device. They share a lot of hardware, and they run on identical software - our 'Venus OS' - therefore firmware numbering is the same; and new version releases always apply to both devices at the same time.

As many of the functions of the two devices are identical, the [CCGX Manual](#) should also be consulted if something is not specifically covered in this VGX manual.

This manual refers to the latest firmware version. A device connected to the internet will perform new-version updates automatically. Check the latest firmware version [here](#).

Venus GX/CCGX comparison table

See [Victron GX product range](#).

1. What's in the Box?

- Venus GX (VGX)
- VE.Can terminator (2 pcs).
- Power cable with inline fuse and M8 terminal eyes for battery- or DC busbar-attachment.
- Terminal Blocks for all the connectors on each side.
- Label showing WiFi key and product details.



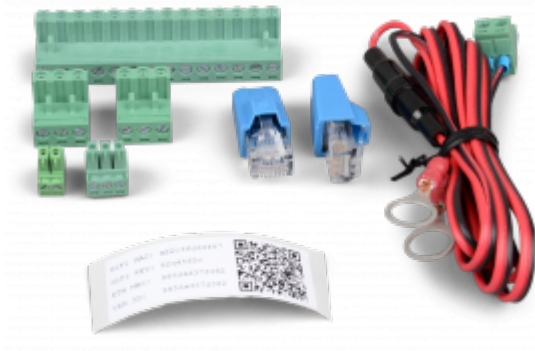

1.1 Overview of connections

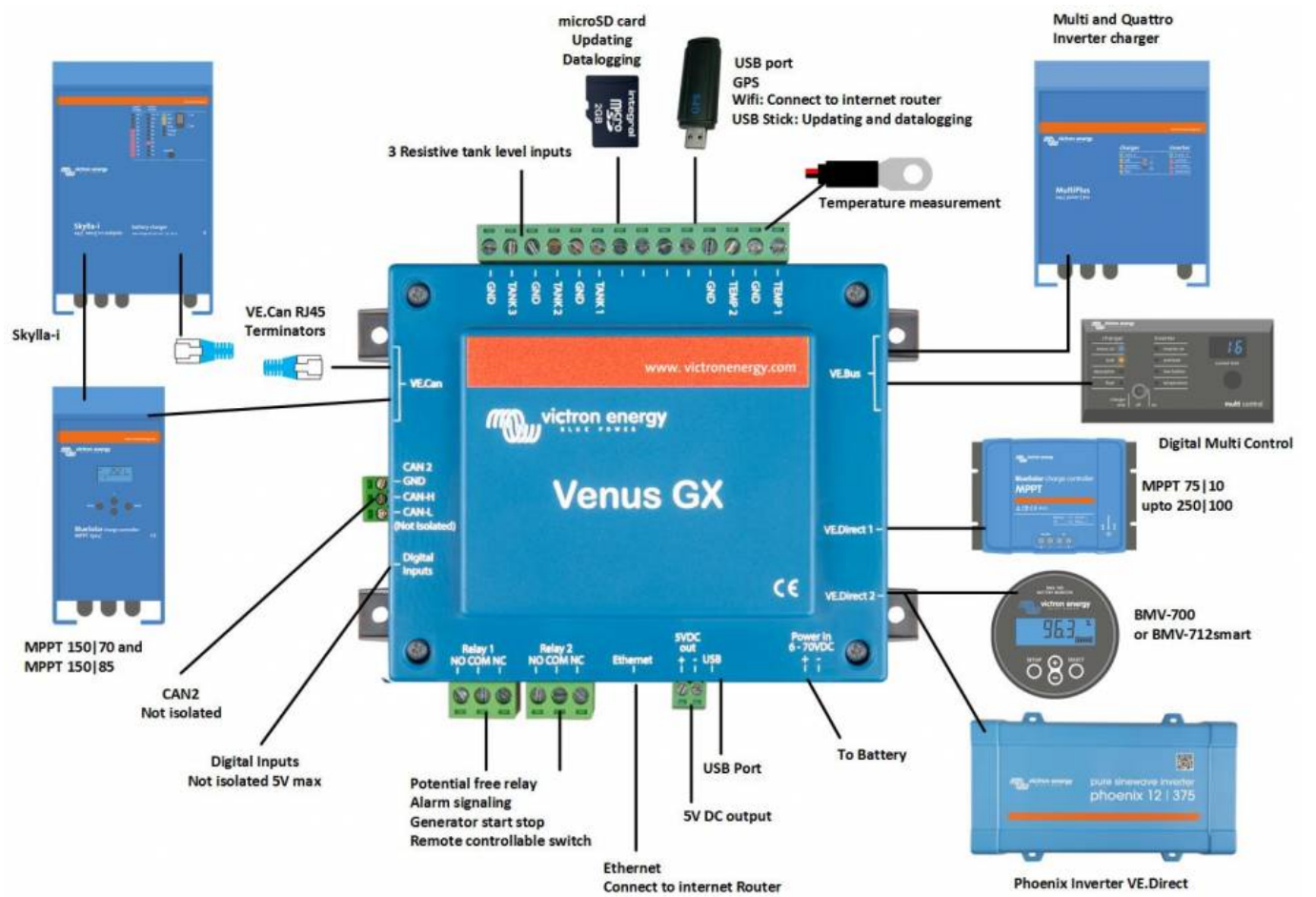

2. Accessing the device

Because the Venus GX has no visual display or buttons, it is accessed for setting-up and monitoring by using the 'Remote Console' feature. You can do this through VRM, using the built-in WiFi Access Point, or by using the local LAN/WiFi network.

2.1 Accessing 'Remote Console' via VRM

Connect the Venus GX to the internet by plugging it into a working Ethernet network which as a DHCP

server (most networks do). It will immediately connect to VRM.

Go to <https://vrm.victronenergy.com/> and follow the instructions to add the device. More information about this is available in the [VRM Manual](#).

When you've done that, click the 'Remote Console' link to open the window, like this:

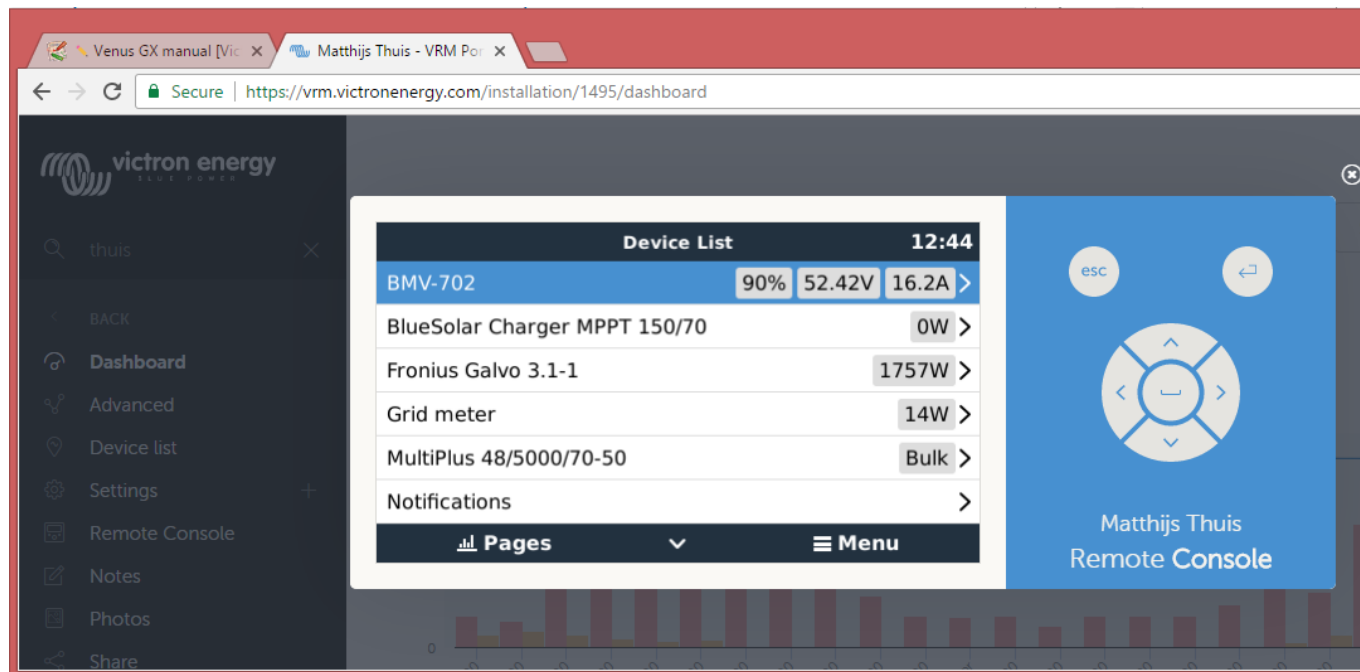

More information about 'Remote Console' on VRM is explained [here](#).

2.2 Accessing 'Remote Console' via the built-in WiFi Access Point

Steps:

1. Make sure you are no further than a few metres away from the Venus GX
2. Go to the WiFi settings on your phone / tablet / laptop.
3. After searching, it will show up in the list:
4. Connect to WiFi using the 'WiFi key' which you will find printed on the side of the box ...and also on a card in the plastic bag - which you should keep in a safe place.
5. Once connected, navigate to 172.24.24.1

Note that for added security it is possible to disable the WiFi Access Point. See Settings → Wi-Fi → Create access point.

Caution: Once WiFi Access is disabled the only way to get it back is by using 'Remote Console' on VRM -which requires a working internet connection; or via 'Remote Console' on LAN which requires a working network connection (but no internet).

2.3 Finding the IP address

If you've accidentally disabled Remote Console on VRM, the only way to re-enable it is via Remote

Console on LAN. And to do that you'll need to find the IP address of the Venus GX. There are several ways of finding it:

IP Address on VRM

On VRM, you'll find the IP address on the Device List page of the installation. Note that this does require the Venus GX to be connected to the internet.

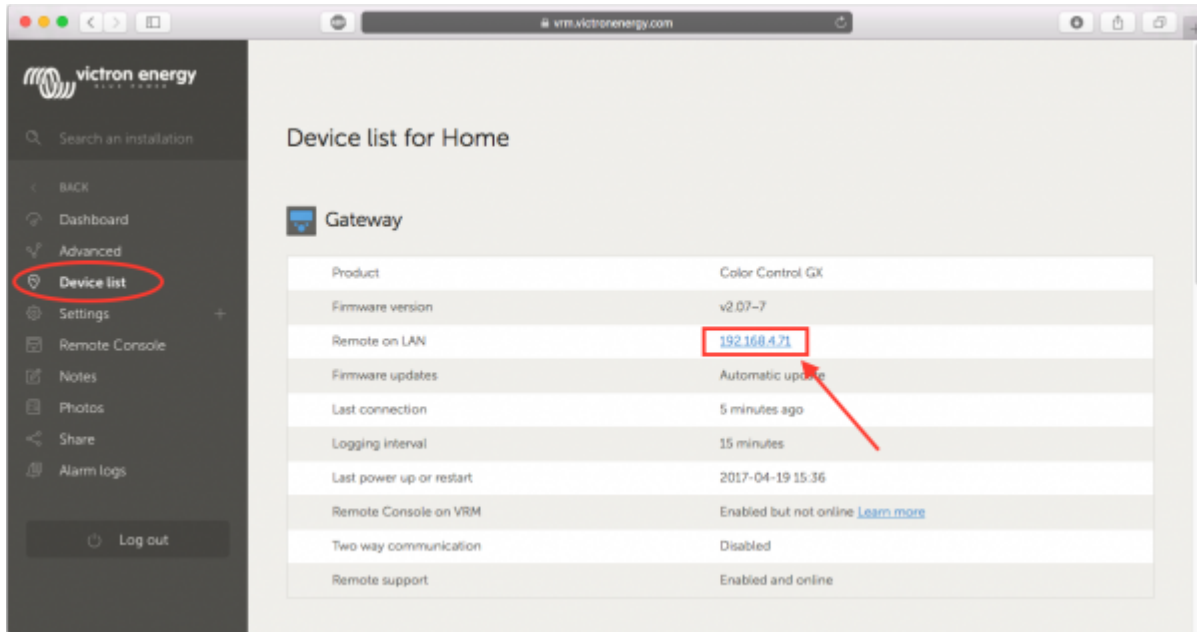

Network (on Microsoft Windows)

In a local network, for example at home, you can also find the Venus GX in the Windows 'Network' overview:

Double-clicking the icon will open up Remote Console on LAN.

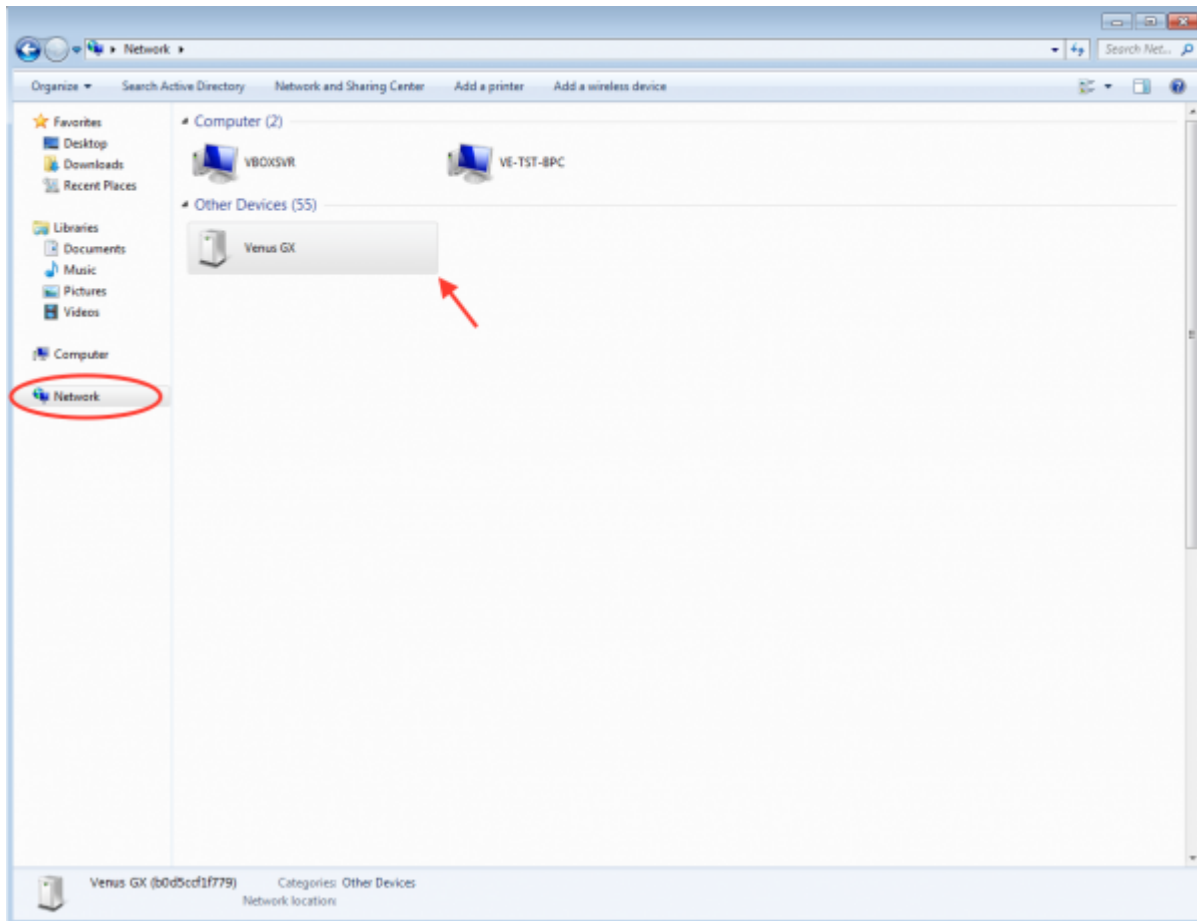

Open the 'Properties' window to see the IP address.

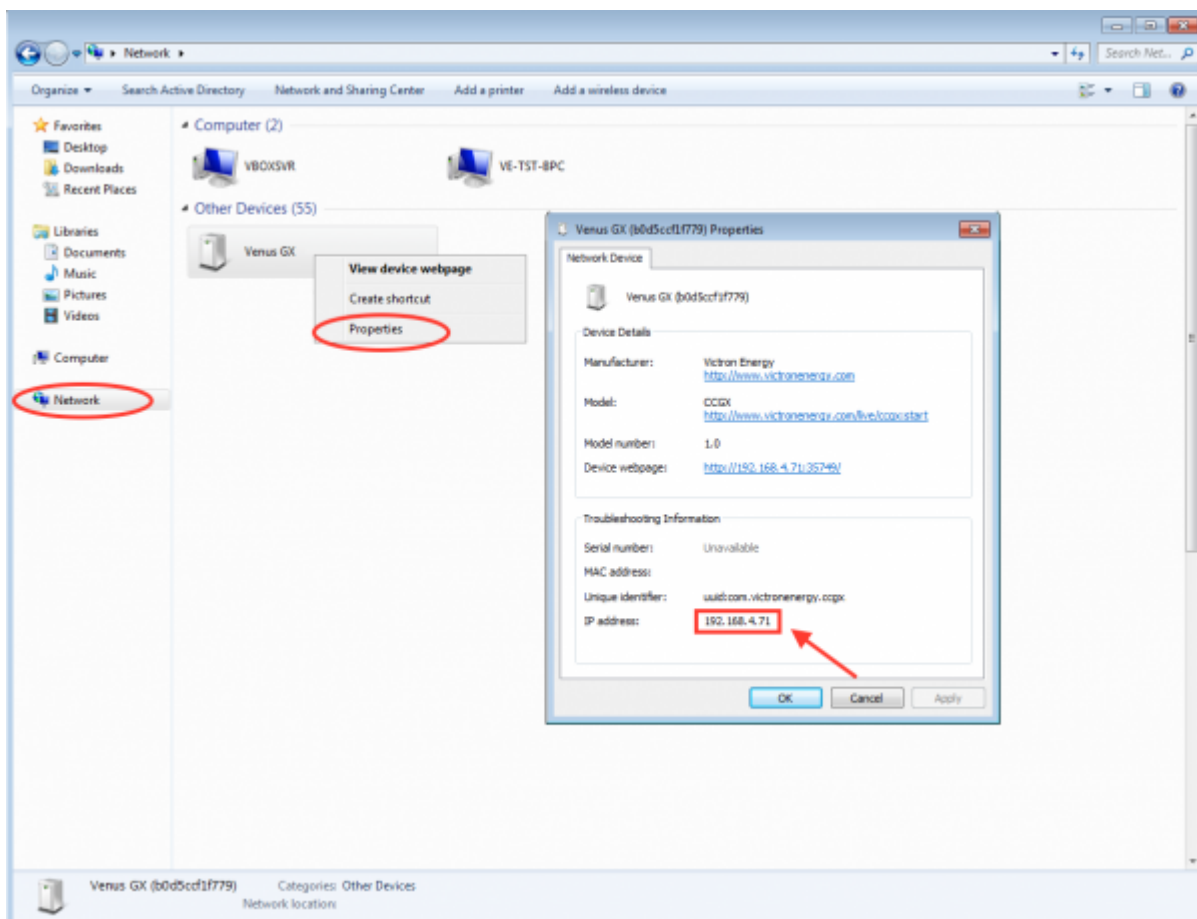

This uses Universal plug-and-play broadcast technology.

3. LEDs and Push-button - explanation

3.1 LEDs

Boot-up

On the side of the Venus GX, there is an LED. During power-up it goes through these states:

- Stage 1: Both green and red illuminate briefly and faintly (it's hard to see the green) for approximately 1 second.
- Stage 2: Red illuminates for approximately 1 second.
- Stage 3: Green illuminates for approximately 0.5 seconds.
- Stage 4: Both green and red illuminate briefly and faintly (it's hard to see the green) for approximately 1 second.

After that the LED will be blinking green continually.

3.2 Small button located to the right of the green 14-Terminal Connector Block

There is at the moment no functions to the button.

4. Digital Inputs

The Venus GX has five digital inputs. The channels are accessible via the RJ-12 socket on the side. This is available for self-wiring by the user/installer.

4.1. Wiring details

The inputs are non-isolated. They operate at 3V3 levels, and can withstand up to 5V input. Each input has an internal 10k pull-up resistor to 3V3. We recommend wiring it to a potential free relay or otherwise open collector/optocoupler output.

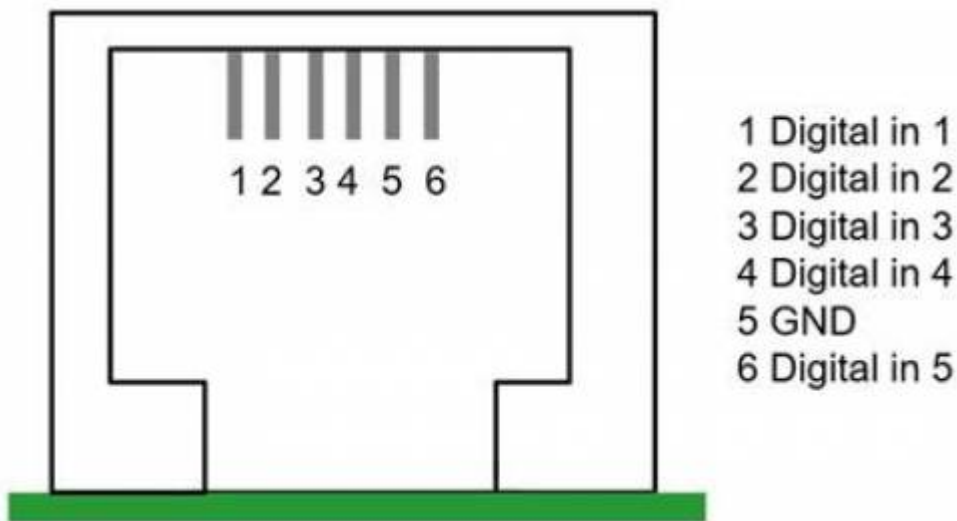

RJ12 pinout	Input
pin1	input1
pin2	input2
pin3	input3
pin4	input4
pin5	gnd
pin6	input5

4.2. Configuration

Each of the digital inputs can be configured as a pulse meter, or as one of a number of predefined sensors that can also be configured as alarms.

The possible configurable functions are:

Function	States
Pulse meter	N/A
Door alarm	Open/Closed
Bilge pump	On/Off
Bilge alarm	Ok/Alarm
Burglar alarm	Ok/Alarm
Smoke alarm	Ok/Alarm
Fire alarm	Ok/Alarm
CO2 alarm	Ok/Alarm
Generator	Running/Stopped

The function of each input can be configured in the GUI under Settings → I/O → Digital Inputs.

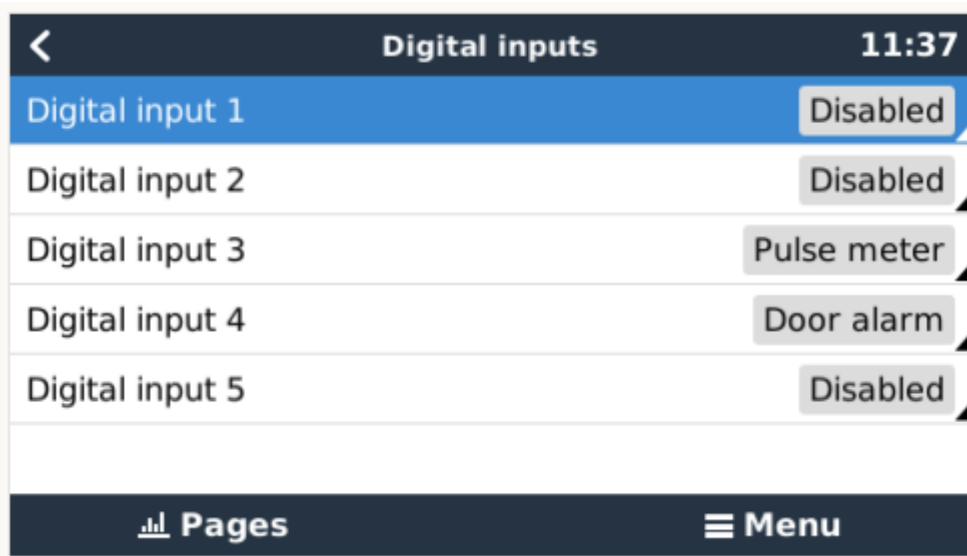

Once the input is configured for its intended purpose, it will show up with other devices.



Other parameters related to that function can be configured by entering the device menu and selecting Setup. For pulse meters, you can configure the unit, the multiplier (the volume represented by each pulse) and reset the counter.

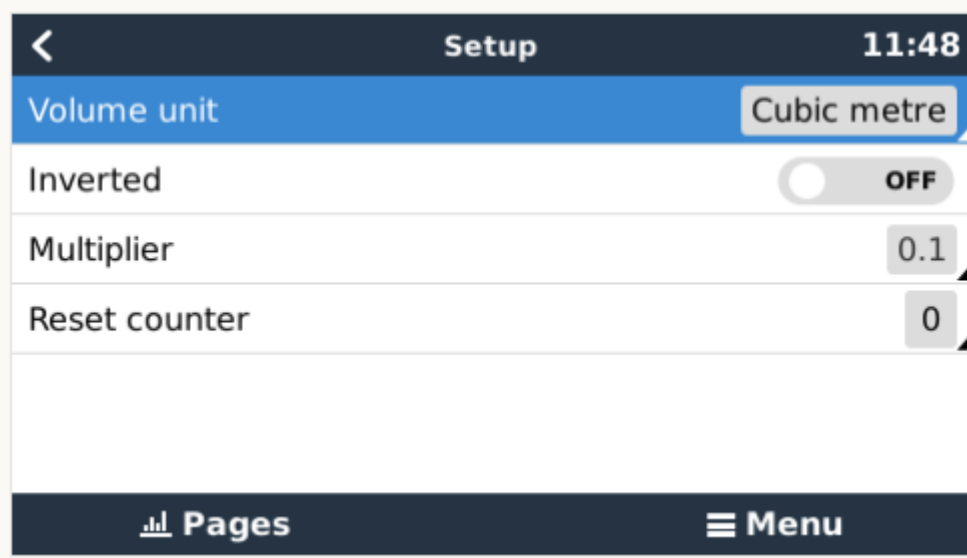

For other sensors and alarms, you can decide whether the input should be treated as an alarm condition, whether the labels should be inverted, and whether the logical levels should be inverted.

- To swap the labels attached to the alarm, set *Inverted* to on.
- If a logical low input (0V) should be considered a positive condition, set *Inverted alarm logic* to on.

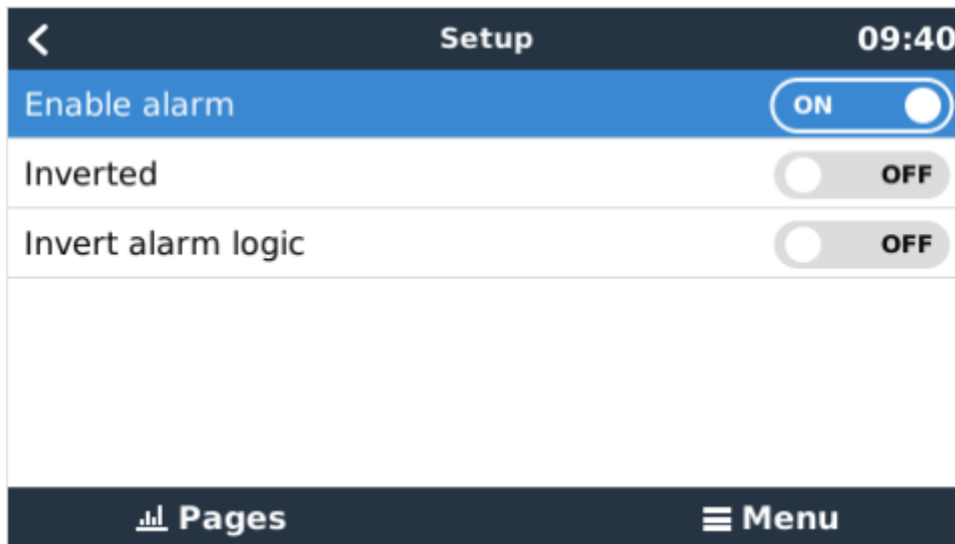

4.3. ModbusTCP

The values/states of the digital inputs are available on ModbusTCP. For more details about this, please download a copy of the document “Modbus-TCP register list” from our website.

5. How does the Venus GX compare with the CCGX?

See [products_running_venus_os](#)

6. Factory reset

There is no factory reset option in the Venus GX.

With regards to locking one-self out, the details:

- The built-in WiFi Access Point is by default enabled, it can be disabled. And its not possible to change the WiFi password.
- Remote Console on LAN is by default enabled. It can be disabled in the GUI, but a reboot will always re-enable it. It is possible to change the password (and thereby locking one-self out).
- Remote Console on VRM is by default enabled, can be disabled.
- Ethernet IP Addressing

Reconnect via Ethernet - DHCP or known manually configured IP Address

With above functionality in mind, the only real way to lock one self out completely is by changing the password of the Remote Console function, and then forgetting that. As long as that is not the case, its always possible to connect the device to an Ethernet network. In the (most common situation) that the Ethernet settings have been left at DHCP; then use VictronConnect to find the GX Device on the network.

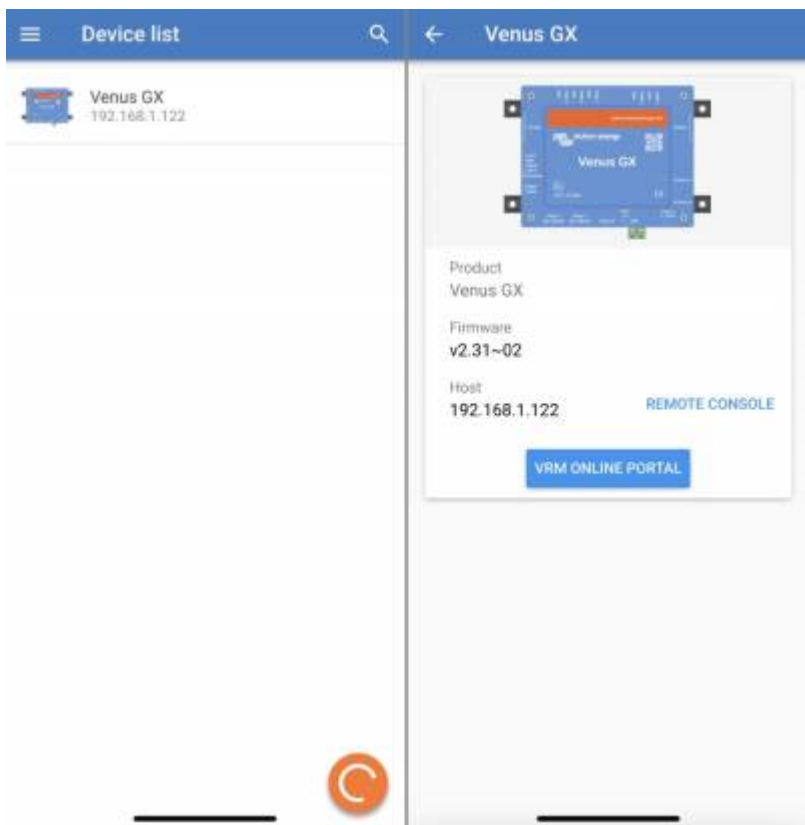

Reconnect via Ethernet - unknown manually configured IP Address

If the Ethernet settings have been changed to a manual IP address, and the details of that are no longer available; then its still possible to recover the connection. Using a feature called link-local addressing. Which we added in v2.30.

The Venus GX always maintains two IP addresses on its ethernet interface: the DHCP/manual one, and a Link-local address.

To connect to the link local address, connect a computer and the Venus GX together (with an ethernet cable); make sure there is no router or DHCP server in the same network. And wait for your computer to obtain a link local address: 169.254.x.x. Then run VictronConnect again. In case the computer does not obtain a link local address by itself, you can also configure it your self. Set your Ethernet interface to manual ip address mode, address 169.254.1.1, subnet 255.255.0.0, and leave all other fields empty.

Improvement coming

This functionality is due for an improvement, a real Factory reset is coming. In the mean time, in case all above doesn't work and you are locked-out, contact your dealer for a replacement.

7. More information

- [ccgx](#)
- [generator_start_stop](#)
- [CCGX Frequently asked questions](#)
- [How to update a GX device](#)
- [CCGX Remote VEConfigure and remote firmware updates](#)
- [VRM Portal](#)
- [VRM Portal - trouble shooting Remote Console](#)
- [Open source](#)

DISQUS

~~DISQUS~~

From:

<https://www.victronenergy.com/live/> - **Victron Energy**

Permanent link:

<https://www.victronenergy.com/live/venus-gx:start?rev=1560059245>

Last update: **2019-06-09 07:47**

