

Hub-4 / grid parallel - manual

Note: make sure to always update all components to the latest software when making a new installation.

Introduction

Hub-4 is a Grid-parallel Energy Storage system, using the Multi or Quattro bidirectional inverter/charger as its main component. It optimizes self-consumption: at times when there is excess PV power, the PV energy is stored in the battery. And that stored energy is then to power the loads at times when there is a shortage of PV power.

The system is managed by the [Color Control GX \(CCGX\)](#), which also provides extensive monitoring, both locally and remotely via our [VRM Portal](#) and the [VRM App](#). The VRM app is available for both iOS and Android.

Schematic overview

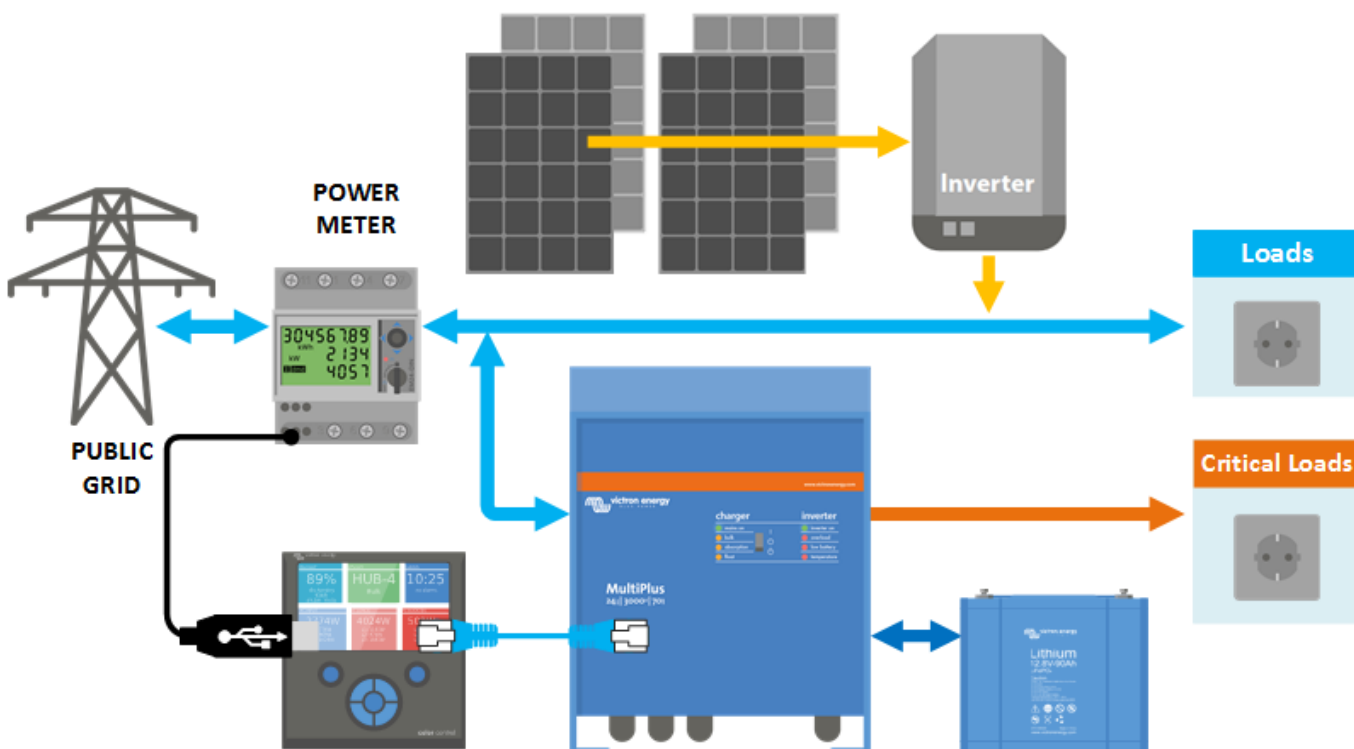

Features

- Grid parallel energy storage system that optimizes self consumption.
- Wide range of available inverter/chargers: 800 VA to 10.000 VA in 12, 24 and 48 VDC.
- Flexible:
 1. a single phase inverter/charger installation in a single-phase system
 2. a single phase inverter/charger installation in a multi-phase system

3. a split- or three-phase inverter/charger system in a multi-phase system

- Both wired and a wireless connection to the meter central distribution box is possible.
- (optional) No-break UPS output.
- (optional) Phase compensation.
- Built-in anti-islanding / loss of mains detection. Currently certified for limited number of countries/models, more certification coming.
- No restrictions on PV Array size.
- No minimum or maximum battery size.
- Suitable for many battery types.
- Three operating modes, from basic to custom, covering both standard and custom systems.
- Free usage of the [VRM Portal](#) and the [VRM App](#) for remote monitoring.
- Winter switch: keep batteries charged in periods where there is a continuous shortage of solar power

Operating modes

1. Standard

The system runs automatically, and uses excess energy harvested during the day to fill the gaps when there is not enough PV power available. Typically in the evening and night. Easy configuration in Assistants and on the Color Control GX.

2. Advanced

Same as standard, but more flexibility is given to implement time shifting, load management or other energy management optimization algorithms. Either by ModbusTCP commands or by running additional self implemented code on the Color Control GX. Often the best of both worlds: complete flexibility and benefit from the VRM Portal and all other functionality already available on the CCGX, without having to add additional cost of extra PLCs or other control modules. [more information](#).

3. Custom

Customer self implements their control loop and grid measurements, and uses the MultiPlus and/or Quattros as simple, remote controllable, bidirectional inverter/chargers that can be set to either charge or discharge an x amount of Watts. [for more information](#).

1. Required parts

Part no.	Description
PMP, CMP or QUA	Multi or Quattro inverter/charger (see Note 1 below)
REL200100000	Wired AC sensor - 1 and 3-phase - max 65A per phase
BPP000300100R	Color Control GX
ASS03006xxxx	RJ-45 UTP Cable
BATxxxxxx	Batteries. (Victron) Lithium batteries are recommended due to their long life
ASS030130010	MK2-USB. Needed during installation to configure the VE.Bus system
ENS Anti-islanding options, choose one of below options:	
No external needed	For certain countries, our Multis and Quattros have built-in certified anti-islanding protection.
RCD000100200	Anti-islanding box 63A single phase - UK (includes the UFR1001E)
RCD000300200	Anti-islanding box 63A single and three phase (includes the UFR1001E)

Part no.	Description
REL100100000	Ziehl anti-islanding relay UFD1001E (Many countries) more info
REL100200000	Ziehl anti-islanding relay SPI1021 (Italy)
Wired AC sensor connection option A: wireless connection between the CCGX and the AC sensor	
ASS300400100	Zigbee to RS485 converter (AC Power adapter and 30cm wire to AC sensor is included)
ASS300400200	Zigbee to USB converter (USB cable is included, connects to the CCGX)
Wired AC sensor connection option B: wired connection between the CCGX and the AC sensor	
ASS030570018	RS485 to USB interface 1.8m
ASS030570050	RS485 to USB interface 5m

Notes:

1. The Multi or Quattro used needs to be a recent type with the new microprocessor (26xxxxx or 27xxxxx). All units currently shipping have this new microprocessor. Also, the Multi or Quattro needs to run the latest 4xx firmware. Contact your Victron representative for the firmware files. Update instructions are [here](#).
2. The RS485 to USB interface cable from the CCGX to the AC sensor can be extended up to 100 meters max.
3. The REL200100000 is the EM24DINAV93XISX from Carlo Gavazzi. Other EM24 models from Carlo Gavazzi can also be used, as the communication is the same. For example the EM24DINAV53DISX, which uses Current Transformers and can therefore work in systems > 63A per phase. Note that this model is not stocked by Victron Energy, we recommend to purchase it locally.

2. Battery, inverter/charger and PV dimensioning

Battery size

There are several factors to take into account when dimensioning the battery:

- Small batteries will be more cost effective: all available storage capacity is used every day
- Small batteries will be charged and discharged with high currents: especially with lead batteries this will reduce battery life time
- Larger batteries, combined with a relatively large PV installation, can store excess power during good days, which can then be used during several consecutive days of bad weather
- Larger batteries provide longer autonomy during a power outage, requires using the UPS output

Inverter/charger size

Because it is installed parallel to the grid and the loads, the inverter size can be reduced to (much) smaller than the max expected nominal and peak load.

For example, to cover the base load of a two person house hold, the MultiPlus xx/800 might already be sufficient. For a household with one family, the MultiPlus xx/3000 can already manage nearly all

appliances, when not more than one of them is running at the same time. This means a MultiPlus xx/3000 can already reduce the power consumption during late spring, summer days and early autumn with sufficient storage to (nearly) zero.

PV Array and PV inverter size

In a Hub-4 installation, the PV Inverters are connected in parallel to the inverter/charger. Because of this, the size of the PV array and the PV inverter is not limited by the maximum nominal power of the inverter/charger. This is in contrast to other AC-Coupled installations, such as Hub-2, where the [Factor 1.0 rule](#) applies.

Note that even in an Hub-4 installation, it is possible to connect AC-Coupled PV power on the output of the inverter/charger. In that case, make sure add the PV Inverter Assistant to the list of installed Assistants in VEConfigure.

3. Single vs multi phase installations

3.1 Single phase inverter/charger system

Phase compensation

Phase compensation, for a single phase inverter/charger installation, part of a multi phase system.

Phase compensation, which is common practice in Germany, is used to have a storage hub connected to only one phase, and compensate on that phase for the other two phases, thereby effectively regulating the total power of all three phases combined.

See the following example, where the Hub is connected to L1, and by compensating for phase L2 and L3 as well, it regulates the total power at the distribution panel to 0 W.

	L1	L2	L3	Total
Load	100 W	400 W	200 W	700 W
Inverter/charger	-700 W	0 W	0 W	-700 W
Distribution box	-600 W	400 W	200 W	0 W

Enabling or disabling phase compensation is done in the Hub-4 settings on the Color Control GX. See the screenshot further down below in this manual.

3.2 Split- and three-phase inverter/charger system

Installation details

- The Multis need to be configured as a three-phase system. Use VE.Bus Quick Configure or

VE.Bus System Configurator for this.

- Update all Multis to firmware 405 or newer
- Install the Hub4 Assistant in all units: all the phase-masters but also all slaves (if any)
- Three phase loads: it is possible to connect three-phase loads to the AC out of the Multis, also called the UPS-output in a Hub-4 system. Those loads will be powered from the battery during a power failure.

Power regulation details - phase compensation setting

In a three-phase Hub-4 system, there is at least one Multi installed on each phase. We recommend leaving phase-compensation setting to its default: enabled. The system will regulate the total power of the three phases to zero. When phase-compensation is disabled, each separate phase is regulated to 0.

With phase-compensation enabled, all the inverter/chargers will either be charging or discharging: the system prevents to charge the battery on one phase, and discharge it on the other phase.

When the system as a whole produces power (PV power exceeds consumption), the Multis on the phases with a net power production will be set to charge the battery. Multis on phases with a net power usage, $P_{pv} < P_{load}$, will be on idle.

When the system as a whole consumes power (Consumption exceeds PV production), the Multis on the phases with a net power usage will discharge the battery to compensate for the shortage. Multis on phases with a net power production will be on idle.

Disabling phase compensation

In a hub-4 system it is still possible to balance the grid power of each phase to 0W. Disable phase compensation. This would however cause significant losses, because power will flow from one phase to another through the DC connections. Causing losses when converting from AC to DC on one phase and then from DC to AC and the other phase.

Phase compensation, balancing the total grid power to 0 is therefore more efficient. It avoids the AC-DC roundtrip losses.

Note on the maximum charge current

In a multi-phase system, the charge current is configured per phase. There is not a total charge current which the system adheres too. This means that, for example when there is a relatively small battery bank, and a huge over production of PV on L1, and not on the other phases, only part of that over production on L1 will be used to charge the battery.

4. Connecting and configuring the AC sensor

A Hub-4 setup requires an AC sensor connected in the main distribution panel: between the grid and installation. This AC sensor has been designed for 3 phase measurement, but can be configured for

single phase support as well.

3-phase setup diagram:

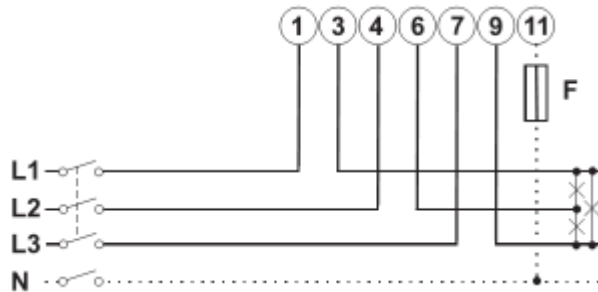

single phase setup diagram:

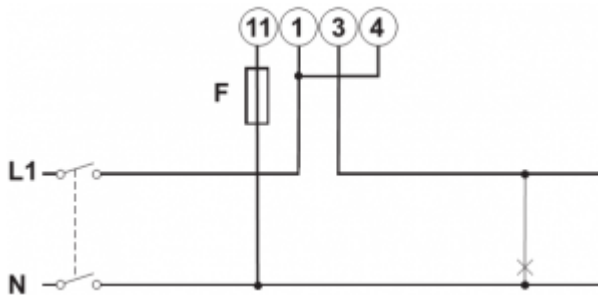

Note the jumper between terminals 1 and 4. You do not need this connection if you have the version AV2 of the sensor.

Meter configuration

Change the front selector of the AC sensor so it is not in the locked state. This will allow the CCGX to automatically configure the meter. The front selector is located next to the display as indicated in the image below.



Option A: Wireless connection to CCGX

1. Connect the Zigbee to USB converter to the CCGX using the supplied USB cable. A few seconds after connecting, the active LED should be on and the TX/RX LED should be blinking (the converter takes its power from the CCGX, so the CCGX needs to be switched on as well).



2. Connect the Zigbee to RS485 converter to the EM24 energy meter:

Converter	Grid meter
GND	Terminal 43
A	Terminal 42

Converter	Grid meter
B	Terminal 41



3. Make sure only one Zigbee device is powered up right now: the Zigbee to USB converter connected to the CCGX. Power down all others. *If you don't do this, the Zigbee to RS485 converter may be connected permanently to another Zigbee device.*

4. Connect the 12V DC power supply to the Zigbee to RS485 converter. When the power is switched on, check the LEDs again.

Option B: Wired connection to CCGX

Connect the meter to the CCGX using the USB to RS485 converter cable:

RS485 Converter	Grid meter
Yellow	Terminal 41
Orange	Terminal 42
Black	Terminal 43

The Red, Green and Brown wire are not used

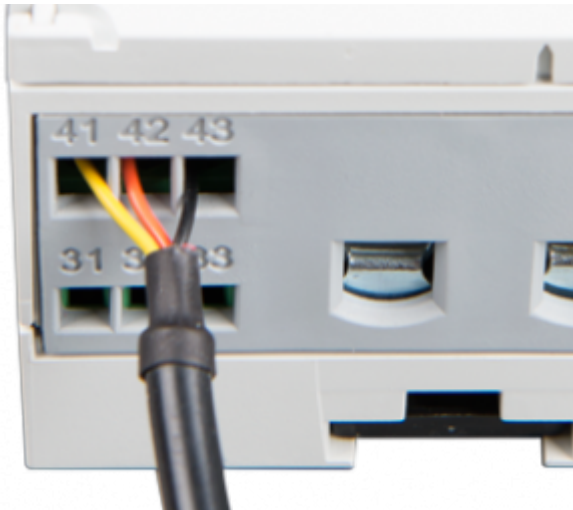

5. Multi/Quattro installation

Follow the instructions as per the standard installation manual that comes with the inverter/charger.

Hub-4 specifics:

- AC Input 1 is connected to the distribution panel of the installation.
- (option) AC Output 1 can be used as a UPS output: in the event of a grid failure, the built-in inverter will power loads connected to AC Output 1.
- (option) Connect a PV Inverter to AC Output 1. Make sure to add the PV Inverter Assistant later during configuration, and note that the [factor 1:1 rule still applies](#).
- (option) Connect MPPT Solar chargers to the DC side of the system. In this case make sure to either use a battery with built-in SOC, like an LG or BMZ battery, or add a BMV Battery monitor. And select that battery or battery monitor as the System Battery Monitor in the Settings → System Setup Menu. Also keep the Sync SOC to VE.Bus option, a setting in that same menu, enabled.

6. Multi/Quattro configuration

Steps:

1. Update the devices to the latest firmware version. Instructions [here](#).
2. Use VEConfigure3 to add the self-consumption Hub-4 Assistant. Instructions on how to add an Assistant [here](#).

Notes:

- Whenever there is more PV power available than necessary to power the loads, the battery will be charged. Charge current and other parameters are configured on the Charger tab in VEConfigure3.
- The Hub-4 Assistant will disable PowerAssist. Please keep this option disabled.
- Make sure to keep the lithium batteries checkbox on the charger page consistent with the battery choice in the Assistant.
- If you have a Multi Compact, check the DIP switches: DIP switch 1 must be on, and DIP switch 2

must be off.

- Do **not** enable the Dynamic current limiter setting in VEConfigure3

7. Controlling depth of discharge

(Note: All absolute voltages mentioned in the text below are for a 12V system and should be multiplied by 2 or 4 for a 24V or 48V system.)

When there is less PV power available than needed by the loads (a PV shortage, at night for example), energy stored in the battery will be used to power the loads. This continues until the battery is considered empty. There are three parameters that check if the battery is empty:

1. Battery State of Charge. Minimum state of charge is configured in the Color Control, and part of the [BatteryLife algorithm](#). See section below.
2. Battery Voltage. See [Dynamic Cut-off section](#), further down below.
3. Low cell signal from BMS

The Sustain mode will be activated automatically after the battery has been flagged as empty. See Sustain section below for more information.

Notes:

- the Minimum SOC threshold is only active while mains is connected. The threshold is ignored during inverter mode, ie. during a grid failure. Only the other two parameters are used: Dynamic cut-off and the low cell signal from the BMS.
- it is also possible to set the minimum state of charge in the Hub-4 Assistant itself, but this is not recommended and we'll remove that option in the near future. Use the same setting in the Color Control GX instead.

Sustain Mode

The purpose of the Sustain Mode is to prevent battery damage caused by leaving batteries in a deeply discharged state. The Sustain Mode is entered after the battery has been discharged, see above.

During Sustain Mode, the batteries will slowly be charged from the grid; maximum charge current is 5 Ampère. The Sustain level is 12.5V for lithium batteries. For non-lithium batteries, the sustain level is 11.5 V for the first 24 hours, and after that it is raised to 12.5 V.

Excess solar power will also be used to charge the batteries. Sustain stops as soon as there has been sufficient excess solar power available to raise the battery voltage 0.1 V above the sustain level. Normal operation will then continue: solar deficits are complemented with power from the battery again.

Dynamic Cut-off

The Hub-4 Assistant includes Dynamic Cut-off. This feature makes the DC-input low shut-down level a function of the battery current drawn from the battery. When a high current is being drawn from the battery, a lower shut-down voltage threshold is being used. For example 10 V. And similarly, when the battery is only being discharged slowly, a high DC cut-off voltage is used, for example 11.5 V.

This way, voltage drop caused by the internal resistance in the battery is compensated. Making battery voltage a much more reliable parameter to stop discharging when a battery is empty.

The picture below shows the default 'Discharge' vs. 'DC input low shut-down voltage' curves for the different battery types. The curve can be adjusted in the assistant.

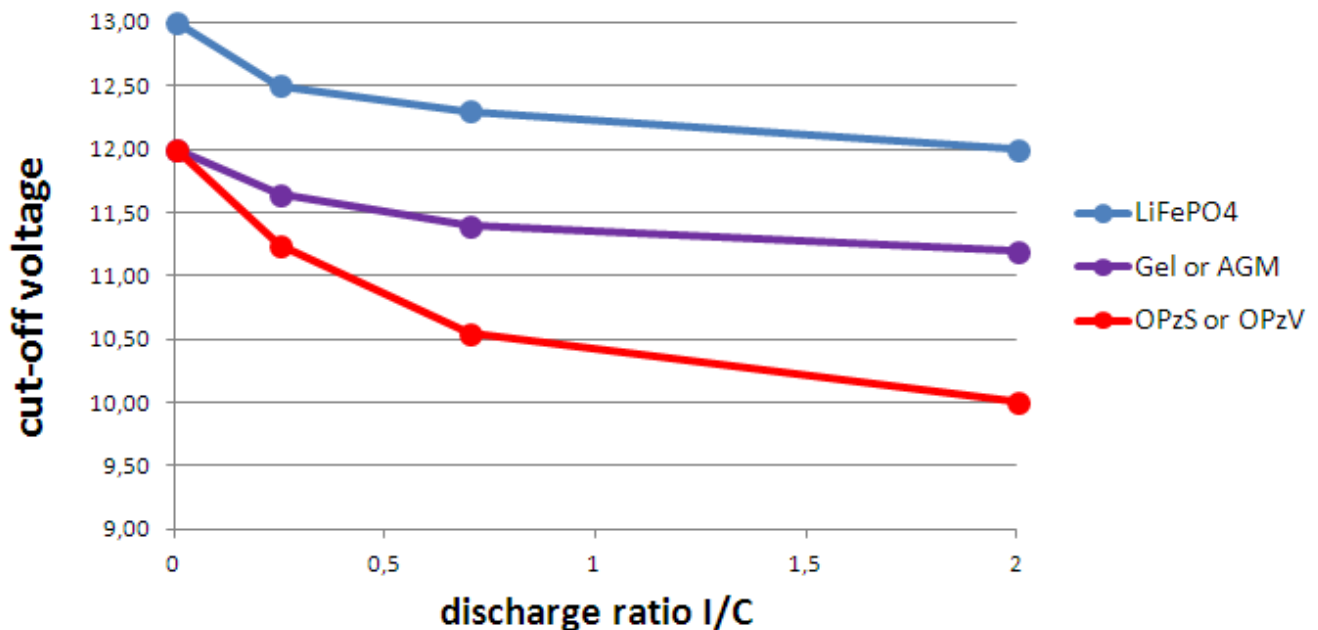

Notes:

- Dynamic cut-off is useful for batteries with a high internal resistance. For example OPzV and OPzS. And it is less relevant for LiFePO4 batteries, because of their low internal resistance. See graph, showing a much flatter curve for the charge current vs disconnect voltage.
- All three DC input low parameters (-shut-down, -restart and -pre-alarm) on the Inverter tab are not effective. They are overridden by the Dynamic cut-off levels, together with the restart level. Which are all configured in the Hub-4 Assistant.
- The Dynamic cut-off mechanism is in effect both when mains is available, and during a mains failure (system is in Inverter mode)

8. Color Control GX configuration

1. Power up the system.
2. After a few seconds, the display will come to life. If not, check the wiring of the system.
3. Within 60 seconds after power up, the CCGX will detect the meter. The meter will show up in the device list on the display. When selected, the CCGX will show a page with current measurements.
4. Select 'Settings' from the device list and select 'Wired AC Sensors'. This will show the list of known AC sensors. In this case there will be a single entry.

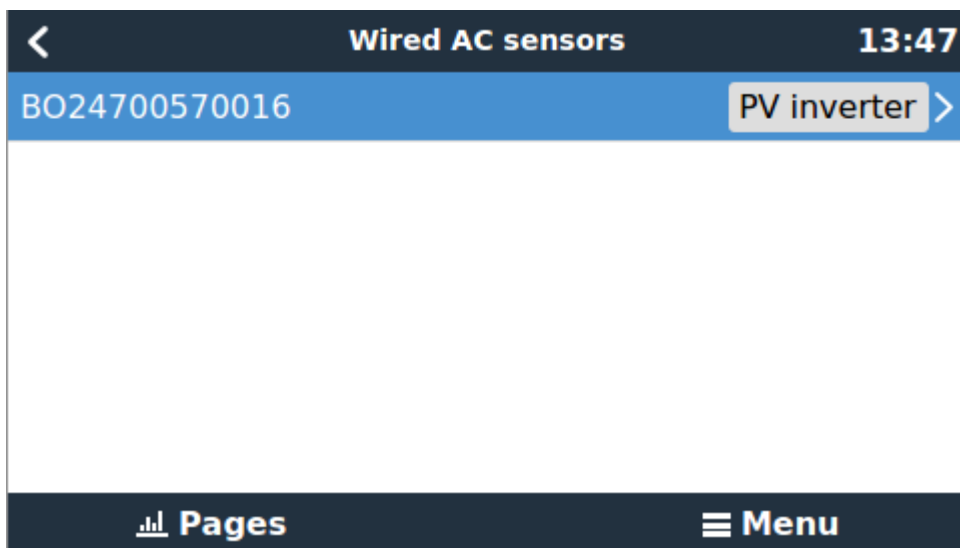

5. Select the entry. A new page will show up with the settings of the AC sensor.

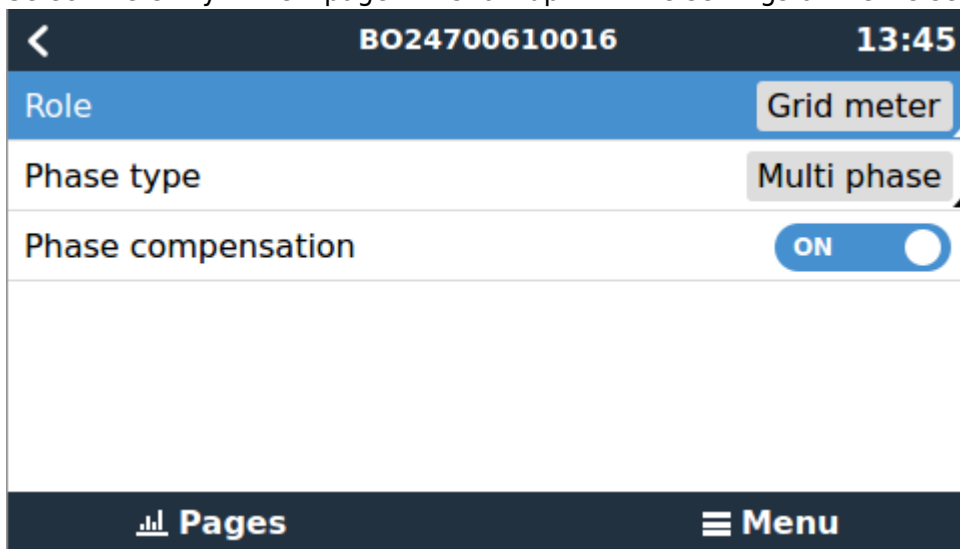

6. Make sure 'Role' is set to 'Grid meter', and 'Phase Type' matches your setup (i.e. single or multi phase).

BatteryLife

The battery life feature prevents low battery state of charge over a long period. This may happen when there is insufficient PV power available to recharge the battery every day, for example in winter.

BatteryLife will make sure that, on average the battery will be recharged to 70 to 100% SOC, every day.

To do this we introduce a dynamic lower limit on the state of charge. Discharging is allowed only if the state of charge exceeds the limit. The limit is adjusted every day. On days with little or no surplus PV power the limit will be raised. And on 'good' days the limit is lowered again.

The limit indicates how much surplus PV power we expect during the day; a low limit means we expect a lot of PV power available to charge the battery. Ensuring that the system will not discharge more energy at night than it is expected to charge the next day.

[This graphs shows a system in the spring, battery state of charge graphed over time. During the week](#)

progressing, more solar energy is becoming available, and you see the depth of discharge being increased. The red line shows how this system would operate without BatteryLife.

BatteryLife (blue) vs. no BatteryLife (red)

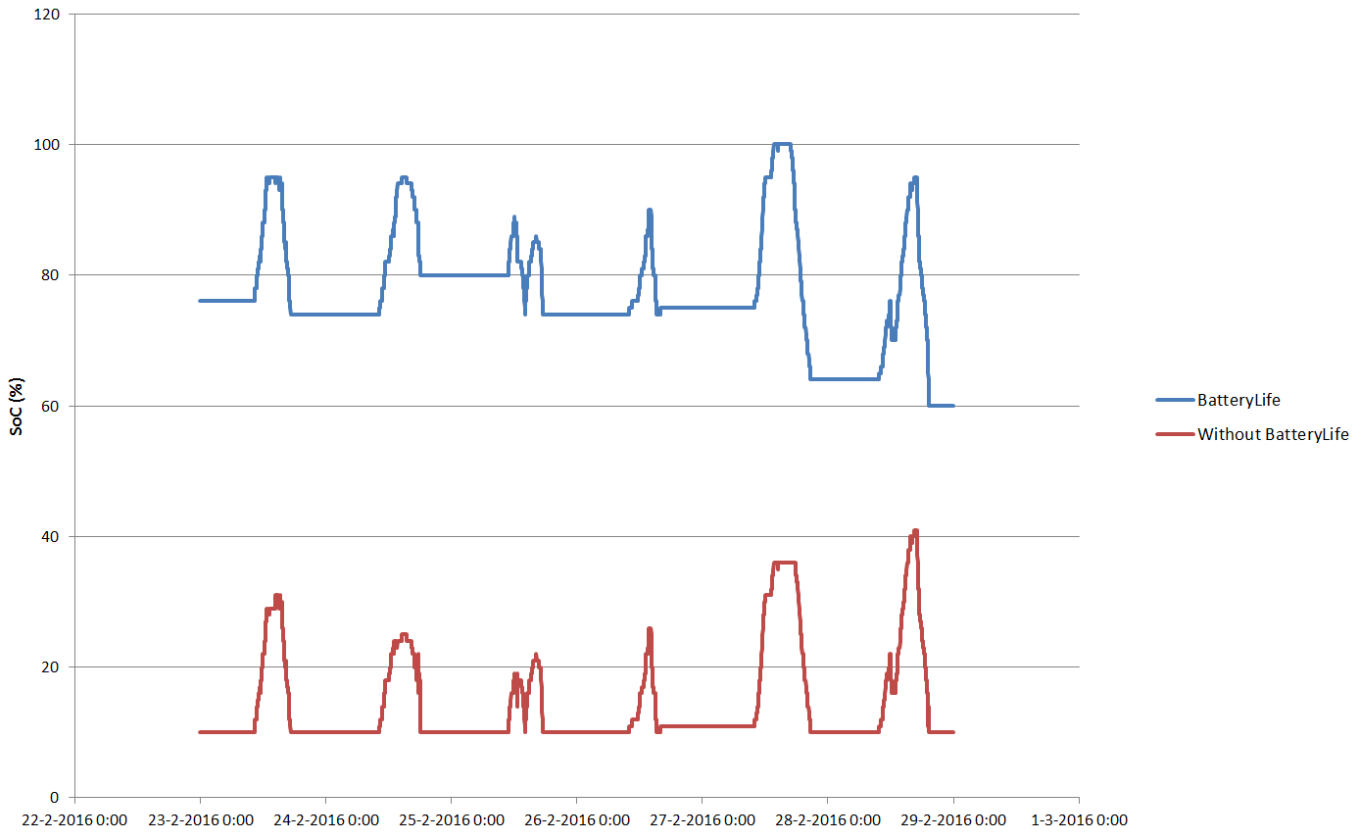

BatteryLife configuration

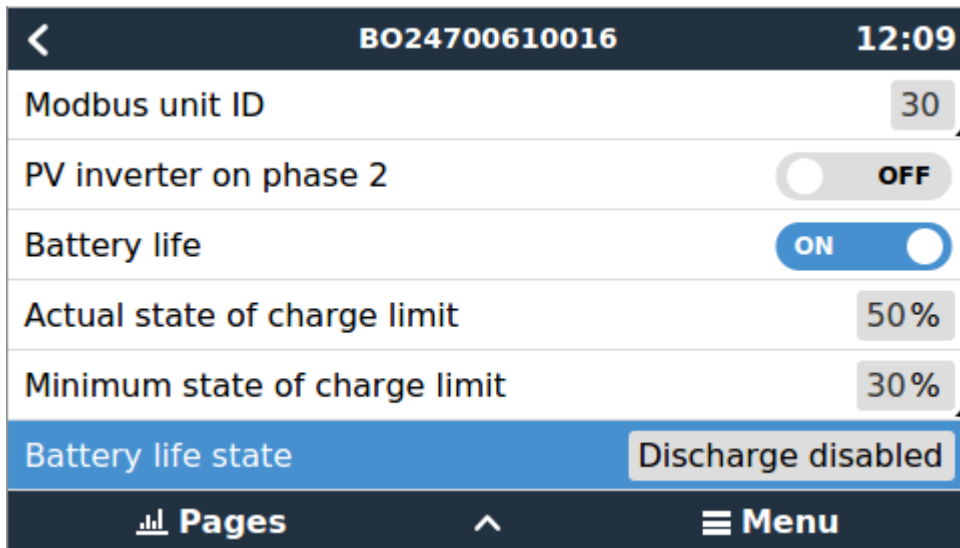

- Actual state of charge limit:
The dynamic state of charge limit. Battery discharge will be disabled when the SoC reached this level. Hub-4 assistant settings (SoC stop level and dynamic cut-off) take priority to this limit. So discharge may be stopped before the limit is reached (sustain mode). The SoC stop level can be disabled safely when battery life is enabled.
- Minimum state of charge limit:
The actual state of charge limit (and therefore the state of charge itself) will never be lowered

below this limit.

- The different Battery Life states are:
 - Self consumption: normal operation (discharge allowed)
 - Discharge disabled: the battery has been discharged to the actual SoC limit. The state will return to *self consumption* whenever the SoC rises 5%. When the system enters this state for the first time on a day, the actual SoC limit will be increased by 5%, and discharging will be allowed after the SoC has risen 10%.
 - Force charge: slow charge started when SoC has been below the actual SoC limit for more than 24 ours. Lasts until the limit is reached. Then the system switches to *Discharge disabled* again.

For further configuration of the Color Control GX, see its [manual](#).

9. Using the Wired HUB-4 AC Sensor to measure PV Inverter output

Instead of used for the Hub-4 regulation, the same three phase meter can be configured to measure output of a PV Inverter. Make sure to check Paragraph 1.3 in the [Color Control GX Manual](#) for other options of measuring PV Inverter output.

Installation is similar to the AC sensor on the grid. Terminals 1, 4 and 7 should face the PV inverter. On the CCGX change the 'Role' of the meter to 'PV inverter'. You can now also chose its 'Position'. In the case of a Hub4 setup, this must be 'Input 1'. If you want to connect a single phase PV inverter to a 3-phase system connect all 3 phases to the grid phasing terminals (3, 6 and 9). Now you can chose on which phase you want the PV inverter by connecting the L1 line of the PV inverter to terminal 1, 4 or 7.

There are 3 options to connect the extra AC sensor:

1. Wired connection with an extra RS485 to USB converter cable. Works just like the grid meter.
2. Wired connection with modbus multidrop (both AC sensors connected to the same RS485 to USB converter cable). In this case you need to change the modbus address of one of the AC sensors (see below).
3. Wireless connection: the AC sensor is connected to an additional Zigbee to RS485 converter just like the grid meter. Also requires change of the modbus address.

Changing the modbus address:

1. Press the joystick down until until the display shows 'Pass'. The joystick on the right side on the display, above the front selector).
2. Press the joystick down again and release immediately.
3. Press the joystick right several times until 'Address' appears. Press the joystick down. Now you can adjust the address by pressing the joystick up and down. Set it to 2.
4. Press down again. 'Baudrate' appears.
5. Press down again twice. 'Address' appears again.
6. Press right until 'End' appears.
7. Press down. The display now shows measurements again.

On a single phase setup, you can use a single AC sensor to measure both grid and PV inverter. For wiring see the diagram below.

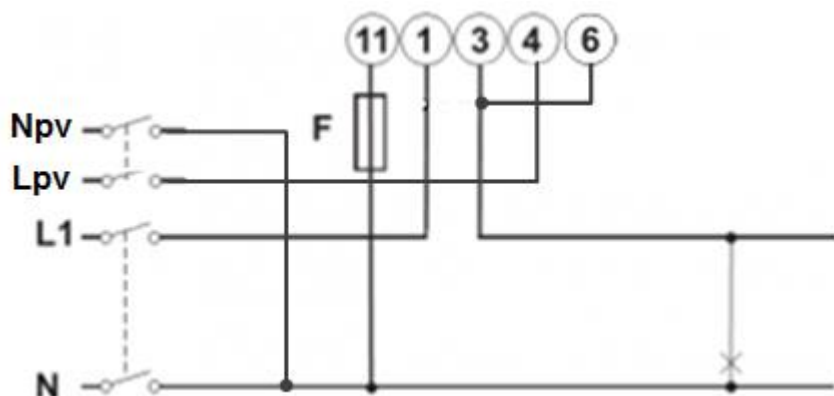

On the CCGX go to the grid meter in the Wired AC sensor settings. Make sure 'Phase type' is set to 'Single phase' and 'PV inverter on phase 2' is enabled.

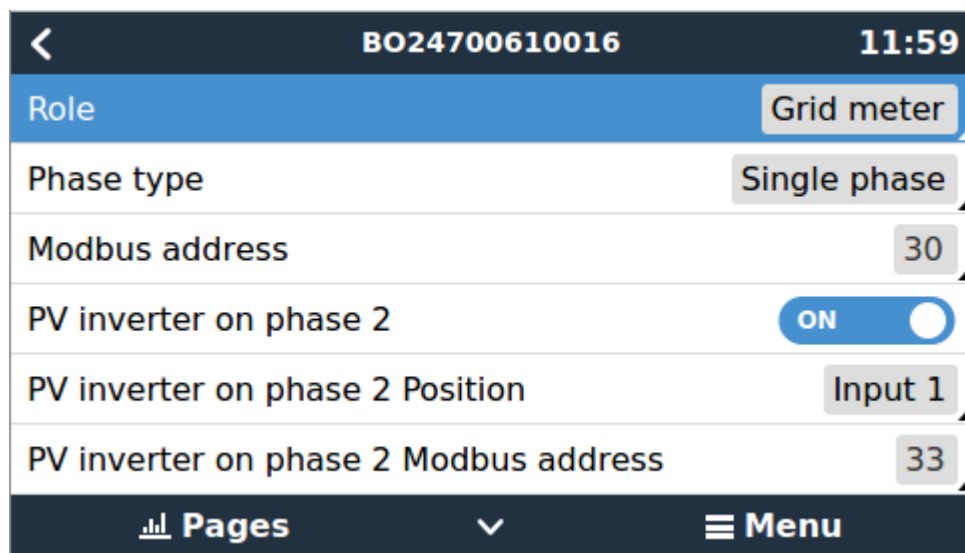

10. FAQ

What happens when the Multi does not receive data from the CCGX / Wired AC Sensor?

It will switch to Bypass, and Sustain mode is still active and will prevent the battery from being discharged below, approximately, 50%. See Paragraph 6 for the details on Sustain and the Sustain Voltages.

Is there a winter mode, like in Hub-2?

Yes.

VEConfigure keeps giving the warning 'Device must be reset'

This message is a bug. There is no need to reset the device. This erroneous indication is solved in firmware version xxyy403.

I get a lot of Low battery pre-alarm warnings ?

Solved by updating to xxyy403 or higher.

Does Hub-4 work for parallel systems?

Yes, Hub-4 works for systems where multiple Multis or Quattros are installed on the same phase and configured to operate in parallel.

Can certain (or all) AC loads be installed on the AC output instead of on the input

Yes that is possible. There are two limitations:

1. When using LG Chem batteries or BMZ batteries. See pages in the [Battery Compatibility section](#) for details.
2. When using the ModbusTCP commands in [Advanced mode 2 or 3](#).

These limitations will be eliminated by means of a software update. When this will be is unfortunately not yet clear.

Can extra (or all) AC-Coupled PV also be installed on the output instead of on the input?

Yes. Make sure to add the PV Inverter Assistant, and note that the [factor 1:1 rule still applies](#).

Can MPPT Solar Charger Controllers be used in Hub-4?

Yes. It is possible to combine PV Inverters with MPPT Charge Controllers. And also making a system without PV Inverters, thus only MPPT Charge Controllers is perfectly possible.

The details:

- Make sure to add a BMV to the system, and make sure that the Color Control uses that State of Charge as the system SOC. See [Settings](#) → [System Setup](#) → [Battery Monitor](#). Note that, in an Hub-4 system, it is not necessary to enable [Synchronize VE.Bus SOC with battery](#).
- The solar power coming through the solar chargers will be used to charge the battery and to power the AC loads. Both AC loads connected in parallel to the inverter/chargers as well as AC

loads connected on the AC Out 1 and 2. See also notes in [chapter 5](#).

- Powering AC loads will have priority over battery charging when state of charge is above the configured minimum state of charge. And, reversely, charging the battery will have priority when the state of charge is below the configured minimum.
- Solar power coming from the MPPT solar chargers will not be fed back into the grid.
- Both Solar Charge Controllers with a VE.Can communication port as well as with a VE.Direct communication port can be used.
- There is no VE.Bus to VE.Can interface cable required, also it is not required to set absorption and float voltages in the mppt higher than the same in the Multi or Quattro.

DISQUS

~~DISQUS~~

From:
<https://www.victronenergy.com/live/> - **Victron Energy**

Permanent link:
https://www.victronenergy.com/live/system_integration:hub4_grid_parallel?rev=1472212342

Last update: **2016-08-26 13:52**

