

Hub-4 / grid parallel - manual

Hub-4 development status

1. The core function works fine
2. Recently, (today) we have updated the assistant. Important improvement: added Sustain, to prevent damaging batteries by leaving them discharged for a long time. More information on Sustain is available below in chapter 6
3. The calculations behind the solar yield and consumption tab don't work 100% yet, is being looked into
4. Winter switch needs to be added (to charge batteries full and then keep them full)
5. Periodic battery maintenance needs to be added, otherwise batteries are never fully charged and this is bad for lead batteries

Introduction

This manual explains how to use a Multi or Quattro bidirectional inverter/charger, combined with batteries, as a grid parallel energy storage system. It optimizes self-consumption: excess PV energy during the daytime is stored in the battery, and used to power the loads at night as well as during the day when there is a shortage of PV power.

The system is managed by the [Color Control GX \(CCGX\)](#), which also provides extensive monitoring, both locally and remotely via our [VRM Portal](#) and the [VRM App](#). The VRM app available for both iOS and Android.

Features

- Grid parallel energy storage system that optimizes self consumption.
- Wide range of available inverter/chargers: 800 VA to 10.000 VA in 12, 24 and 48 VDC.
- Both wired and a wireless connection to the meter central distribution box is possible.
- (optional) No-break UPS output.
- (optional) Phase compensation.
- Built-in certified anti-islanding (limited nr. models/countries only, more models later in 2015).
- No restrictions on PV Array size.
- No minimum or maximum battery size.
- Suitable for many battery types.
- Three operating modes, from basic to custom, covering both standard and highly integrated systems.
- Free usage of the [VRM Portal](#) and the [VRM App](#) for remote monitoring.

Operating modes

1. Standard: the system runs automatically, and uses excess energy harvested during the day to fill the gaps when there is not enough PV power available. Easy configuration in Assistants and on the Color Control GX.
2. Advanced: same as standard, but more flexibility is given to implement time shifting, load

management or other energy management optimization algorithm. Either by ModbusTCP commands or by running additional self implemented code on the Color Control GX. Often the best of both worlds: complete flexibility and benefit from the VRM Portal and all other functionality already available on the CCGX, without having to add additional cost of extra PLCs or other control modules.

3. Custom: customer self implements their control loop and grid measurements, and uses the MultiPlus and/or Quattros as simple, remote controllable, bidirectional inverter/chargers that can be set to either charge or discharge an x amount of Watts.

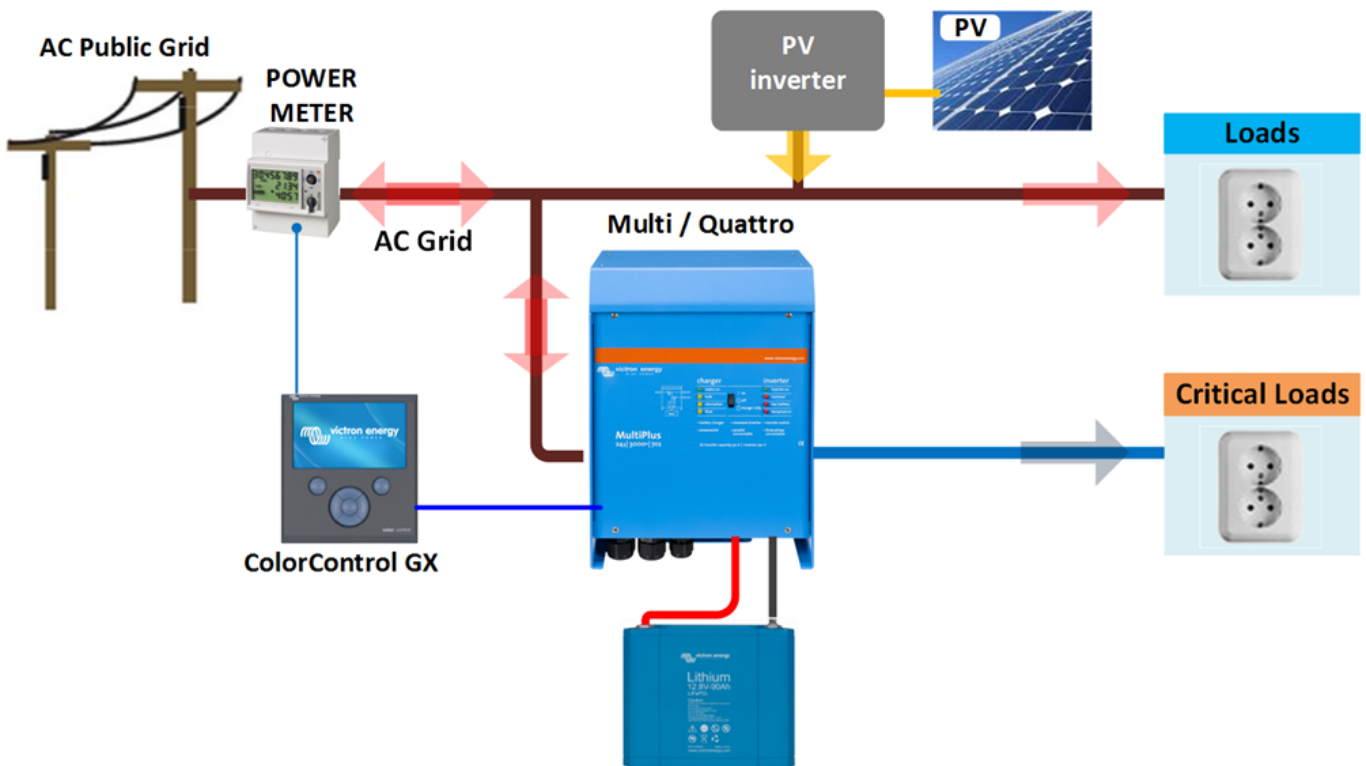

1. Required parts

Part no.	Description
PMP, CMP or QUA	Multi or Quattro inverter/charger (see Note 1 below)
REL200100000	Wired AC sensor HUB-4 for 1 and 3-phase - I _{max} 65A
BPP000300100R	Color Control GX
ASS03006xxxx	RJ-45 UTP Cable
BATxxxxxx	Batteries. Lithium batteries are recommended due to their long life
ENS Anti-islanding options, choose one of below options:	
No external needed	For certain countries, our Multis and Quattros have built-in certified anti-islanding protection.
RCD000100200	Anti-islanding box 63A single phase - UK (includes the UFR1001E)
RCD000300200	Anti-islanding box 63A single and three phase (includes the UFR1001E)
REL100100000	Ziehl anti-islanding relay UFD1001E (Many countries) more info
REL100200000	Ziehl anti-islanding relay SPI1021 (Italy)
Grid sensor connection option A: wireless connection between the CCGX and the AC sensor	

Part no.	Description
ASS300400100	Zigbee to RS485 converter (AC Power adapter and 30cm wire to AC sensor is included)
ASS300400200	Zigbee to USB converter (USB cable is included, connects to the CCGX)
Grid sensor connection option B: wired connection between the CCGX and the AC sensor	
ASS030570018	RS485 to USB interface 1.8m
ASS030570050	RS485 to USB interface 5m

Notes:

1. The Multi or Quattro used needs to be a recent type with the new microprocessor (26xxxxx or 27xxxxx). All units currently shipping have this new microprocessor. Also, the Multi or Quattro needs to run the latest 3xx firmware. Contact your Victron representative for the firmware files. Update instructions are [here](#).
2. The RS485 to USB interface cable can be extended up to 100 meters.

2. Battery, inverter/charger and PV dimensioning

Battery size

TODO: explain requirements and dimensioning considerations for the batteries.
Advantage/disadvantage of using a smaller/bigger battery.

The advantage of a smaller battery is the price. Due to the fact, that it will be charged and discharged more and at a higher current in such a case lithium batteries will have distinct advantages, especially with their increased lifetime. The batteries might also be discharged on such days where clouds dominate the skies. In this case being able to charge the batteries quickly brings many advantages and increases the self-sufficiency quota for that day.

Inverter/charger size

TODO finish this text.

Because parallel to the grid and the loads (except for the UPS loads) the inverter size can be reduced to (much) smaller than the max expected nominal and peak load.

Examples; if you want to cover the base load of a house the MultiPlus xx/800 might already be sufficient. For a household with one family, the MultiPlus xx/3000 can already manage nearly all appliances, when not more than one of them is running at the same time. This means a MultiPlus xx/3000 can already reduce the power consumption during late spring, summer days and early autumn with sufficient storage to (nearly) zero.

PV Array and inverter size

In a Hub-4 installation, the PV Inverters are connected in parallel to the inverter/charger. Because of this, the size of the PV array and the PV inverter is not limited by the maximum nominal power of the

inverter/charger. This is in contrast to other AC-Coupled installations, such as Hub-2, where the [Factor 1.0 rule](#) applies.

3. Multi phase installations and phase (optional) compensation

Phase compensation

Phase compensation, which is common practice in Germany, is used to have a storage hub connected to only one phase, and compensate on that phase for the other two phases, thereby effectively regulating the total power of all three phases combined.

See the following example, where the Hub is connected to L1, and by compensating for phase L2 and L3 as well, it regulates the total power at the distribution box to 0 W.

	L1	L2	L3	Total
Load	100 W	400 W	200 W	700 W
Inverter/charger	-700 W	0 W	0 W	-700 W
Distribution box	-600 W	400 W	200 W	0 W

Enabling or disabling phase compensation is done in the Hub-4 settings on the Color Control GX. See the screenshot further down below in this manual.

Split- and three-phase installations

It is not yet possible to install an inverter/charger on multiple phases. This will be made possible by a (free) firmware update, expected in 2015 Q4. In such a system, there will be one meter, multiple inverter/chargers, configured into a split or three-phase group, each loaded with the Hub-4 Assistant.

4. Connecting and configuring the AC sensor

A Hub-4 setup requires an AC sensor connected in the main distribution panel: between the grid and installation. This AC sensor has been designed for 3 phase measurement, but can be configured for single phase support as well.

3-phase setup diagram:

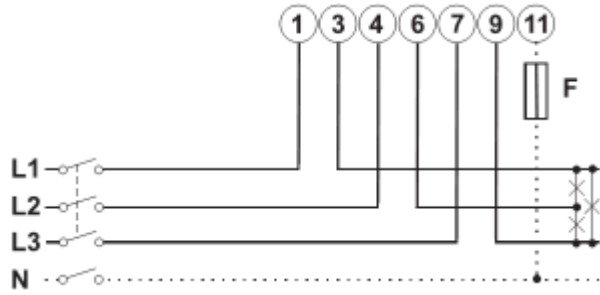

single phase setup diagram:

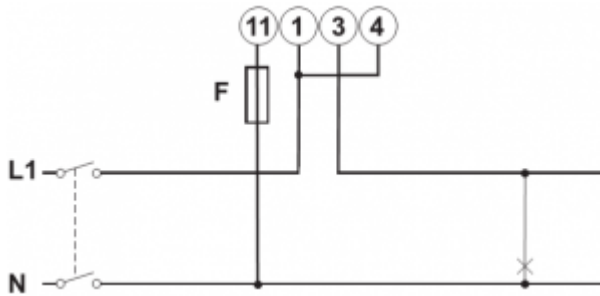

Note the jumper between terminals 1 and 4.

Meter configuration

Change the front selector of the AC sensor so it is not in the locked state. This will allow the CCGX to automatically configure the meter. The front selector is located next to the display as indicated in the image below.



Option A: Wireless connection to CCGX

1. Connect the Zigbee to USB converter to the CCGX using the supplied USB cable. A few seconds after connecting, the active LED should be on and the TX/RX LED should be blinking (the converter takes its power from the CCGX, so the CCGX needs to be switched on as well).



2. Connect the Zigbee to RS485 converter to the EM24 energy meter:

Converter	Grid meter
GND	Terminal 43
A	Terminal 42
B	Terminal 41



3. Make sure only one Zigbee device is powered up right now: the Zigbee to USB converter connected to the CCGX. Power down all others. *If you don't do this, the Zigbee to RS485 converter may be connected permanently to another Zigbee device.*

4. Connect the 12V DC power supply to the Zigbee to RS485 converter. When the power is switched on, check the LEDs again.

Option B: Wired connection to CCGX

Connect the meter to the CCGX using the USB to RS485 converter cable:

RS485 Converter	Grid meter
Yellow	Terminal 41
Orange	Terminal 42
Black	Terminal 43

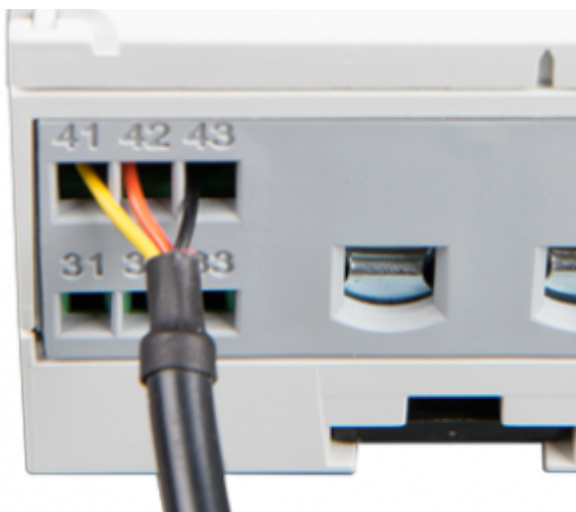

5. Multi/Quattro installation and configuration

First, follow the instructions as per the standard installation manual. AC Input 1 is connected to the distribution panel of the installation. And, optionally, AC Output 1 can be used as a UPS output, to power its loads during a grid failure.

Then use VEConfigure3 to [load the assistant self consumption Hub-4](#) into the device.

If you have a Multi Compact, check the DIP switches: DIP switch 1 must be on, and DIP switch 2 must be off.

If you used an earlier (beta) version of the assistant, make sure to remove it from the *private assistant directory* in VE configure, or disable the directory. You can set the private directory in the *Assistant Tools* tab within *Assistants* tab.

6. Battery charging and discharging behavior

(Note: All absolute voltages mentioned in the text below are for a 12V system and should be multiplied by 2 or 4 for a 24V or 48V system.)

- When ordered to discharge, the Multi will continue to discharge the battery until it has reached the **DC input low shut-down** parameter, configured on the Inverter tab of VEConfigure. Note that the minimum feed-in working voltage is 10.2V, so when **DC input low shut-down** is set below 10.2V, 10.2V will be used instead.
- Besides looking at voltage, it is also possible to configure the Multi to stop discharging when the low SOC threshold is met. Usage of this threshold is optional, and configuration is done in the Hub4 assistant settings.
- The charge process will follow the standard charge profile, as configured on the Charger tab in VEConfigure3.
- The charge algorithm will be reset to bulk every time the battery voltage drops below the reset voltage. For lithium batteries (checkbox on the charger tab) this voltage is Float - 0.2V, with a minimum of 13.5V. For other batteries, the reset voltage is Float - 1.3V with a minimum of 12.9V. The delay depends on the difference between the battery voltage and the reset voltage. The bigger the difference the smaller the delay. Approximately 60 seconds for 0.1V difference and 3 seconds for a 2V difference.
- The assistant will disable PowerAssist. Please keep this option disabled.
- Please keep the lithium batteries checkbox on the charger page consistent with the battery choice in the assistant.

Sustain Mode

The purpose of the Sustain Mode is to prevent leaving batteries in a deeply discharged state during several days. The Sustain Mode is entered when during 30 seconds the following two conditions are met without interruption:

1. the battery voltage is below the sustain level: 12.5V for Lithium batteries and 12V for other batteries
2. the current drawn from the battery is smaller than 1/10th of the battery capacity

During Sustain Mode, the charger is enabled to keep the DC voltage at the sustain level. The maximum charge current during system is 5A. Sustain mode is left as soon as the battery voltages rises 0.1V above the sustain level.

Note that the normal Hub-4 regulation is suspended during Sustain. And note that, for non-lithium systems, the sustain level is 12 V for the first 24 hours, and after that it is raised to 12.5 Volts DC.

DC voltages specified are for a 12V system. These voltages should be multiplied by 2 or 4 for a 24V or 48V system.

7. Color Control GX configuration

1. Power up the system.

2. After a few seconds, the display should come to life. If not, check the wiring of the system.
3. Within 60 seconds after power up, the CCGX will detect the meter. The meter will show up in the device list on the display. When selected, the CCGX will show a page with current measurements.
4. Select *Settings* from the device list and select *Wired AC Sensors*. This will show the list of known AC sensors. In this case there will be a single entry.

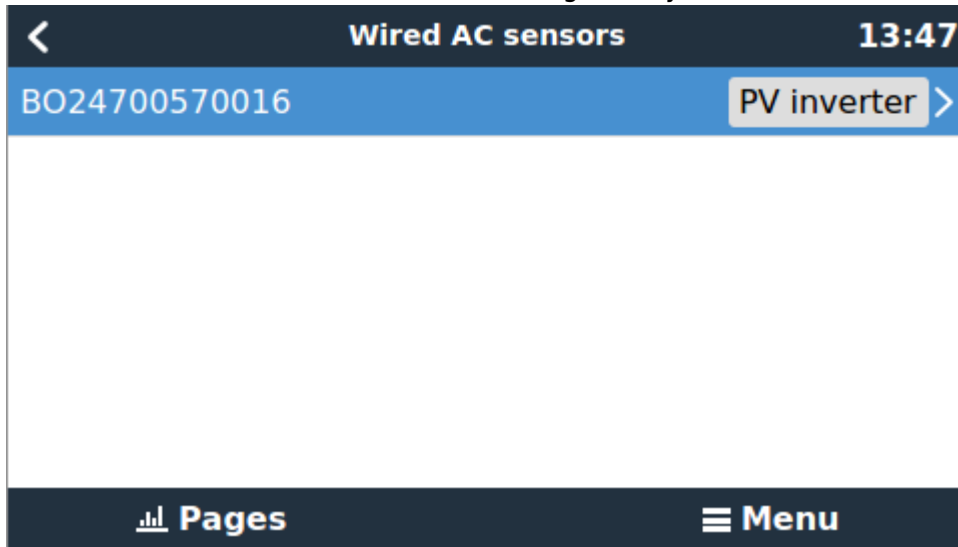

5. Select the entry. A new page will show up with the settings of the AC sensor.

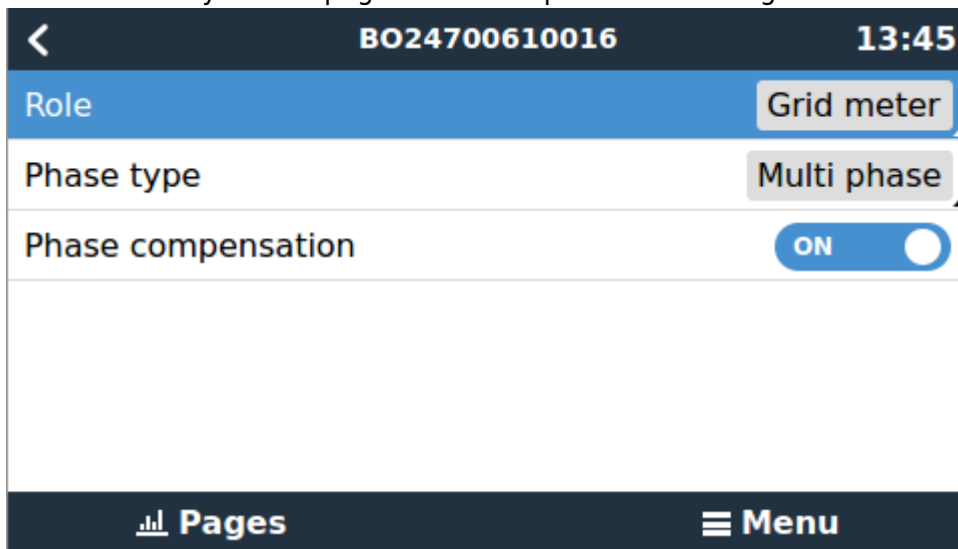

6. Make sure *Role* is set to *Grid meter*, and *Phase Type* matches your setup (ie. single or multi phase).
7. For further configuration, see the [Color Control GX manual](#).

Note that the following features are not yet available and will be added to the Color Control GX and the VRM app soon:

1. Add a pages overview for Hub-4. It will look like this:

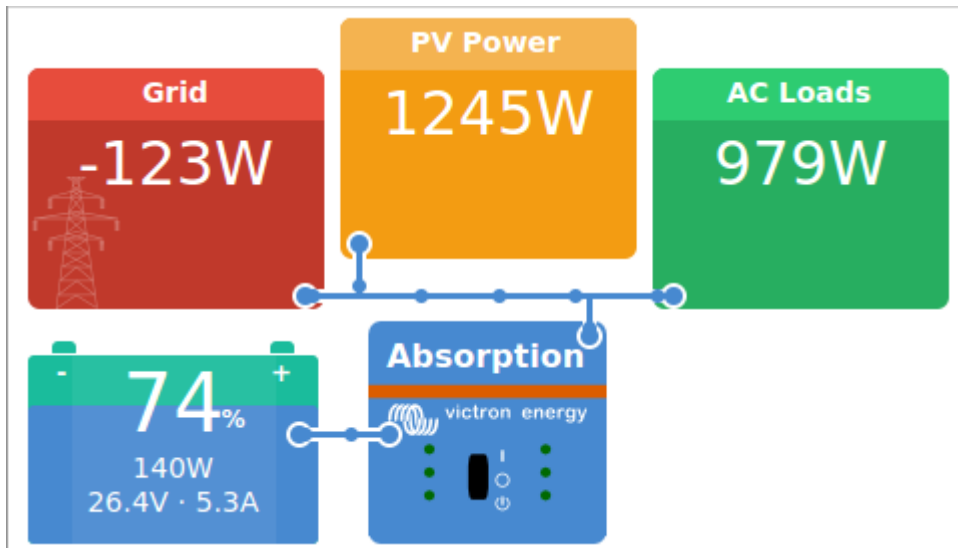

2. Add support for a Hub-4 schematic in the iOS and Android app

8. Using the Wired HUB-4 AC Sensor to measure PV Inverter output

Instead of used for the Hub-4 regulation, the same three phase meter can be configured to measure output of a PV Inverter. Make sure the check Paragraph 1.3 in the [Color Control GX Manual](#) for other options of measuring PV Inverter output.

Installation is similar to the AC sensor on the grid. Terminals 1, 4 and 7 should face the PV inverter. On the CCGX change the *Role* of the meter to *PV inverter*. You can now also chose its *Position*. In the case of a Hub4 setup, this must be *Input 1*.

There are 3 options to connect the extra AC sensor:

1. Wired connection with an extra RS485 to USB converter cable. Works just like the grid meter.
2. Wired connection with modbus multidrop (both AC sensors connected to the same RS485 to USB converter cable). In this case you need to change the modbus address of one of the AC sensors (see below).
3. Wireless connection: the AC sensor is connected to an additional Zigbee to RS485 converter just like the grid meter. Also requires change of the modbus address.

Changing the modbus address:

1. Press the joystick down until until the display shows 'Pass'. The joystick on the right side on the display, above the front selector).
2. Press the joystick down again and release immediately.
3. Press the joystick right several times until 'Address' appears. Press the joystick down. Now you can adjust the address by pressing the joystick up and down. Set it to 2.
4. Press down again. 'Baudrate' appears.
5. Press down again twice. 'Address' appears again.
6. Press right until 'End' appears.
7. Press down. The display now shows measurements again.

Note that if you own a Fronius PV inverter with a data manager card, the CCGX can read out the inverter directly, so you do not need to install an AC sensor on the inverter output. [This page](#) explains how to connect one or more Fronius PV inverters to the CCGX.

9. FAQ

How does the Multi behave when it no longer receives data from the energy monitor?

It will switch to Bypass, and Sustain mode is still active and will prevent the battery from being discharged below, approximately, 50%. See Paragraph 6 for the details on Sustain and the Sustain Voltages.

Note that we changed this behavior a few times during development of the Hub-4 Assistant. Make sure to run the latest Hub-4 Assistant. You can see the version under the 'Add Assistants' button, latest Hub-4 Assistant is current 014E, released on September 18th 2015.

Is there a winter mode, like in Hub-2?

No not yet.

DISQUS

~~DISQUS~~

From:
<https://www.victronenergy.com/live/> - **Victron Energy**

Permanent link:
https://www.victronenergy.com/live/system_integration:hub4_grid_parallel-ccgx_control_loop?rev=1442926795

Last update: **2015-09-22 14:59**

