

ESS Design & installation manual

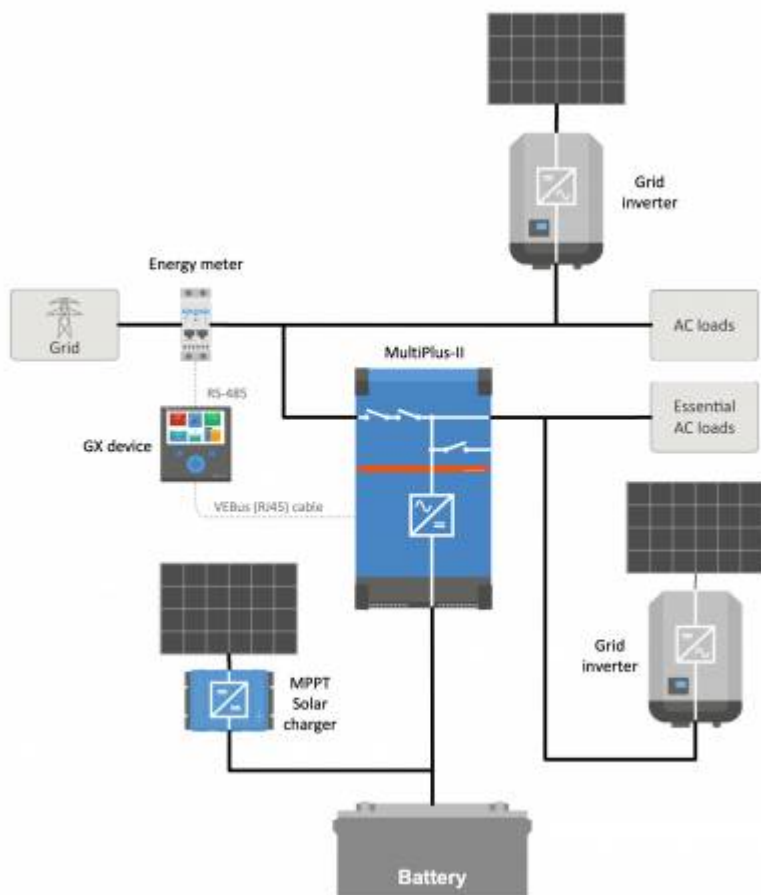

1. ESS Introduction & features

What is ESS?

An Energy Storage System (ESS) is a specific type of power system that integrates a power grid connection with a Victron Inverter/Charger, [GX device](#) and battery system. It stores solar energy into your battery during the day, for use later on when the sun stops shining.

It allows for time shifting power, charging from solar, providing grid support, and exporting power back to the grid.

When an ESS system is able to produce more power than it can use and store, it can sell the surplus to the grid; and when it has insufficient energy or power, it automatically buys it from the grid.

In the ESS system, there must at least be one inverter/charger and also a [GX device](#) such as:

- [Cerbo GX](#)
- [Venus GX](#)

Other components can be added when needed, [see chapter 2](#).

When is it appropriate to use ESS?

Use ESS in a self-consumption system; a backup system with solar, or a mixture of both: For example you can use 30% of the battery capacity for self-consumption, and keep the other 70% available as a backup in the event of utility grid failure.

Optimizing self-consumption:

When there is more PV power than is required to run loads, the excess PV energy is stored in the battery. That stored energy is then used to power the loads at times when there is a shortage of PV power.

The percentage of battery capacity used for self-consumption is configurable. When utility grid failure is extremely rare it could be set to 100%. In locations where grid failure is common - or even a daily occurrence - you might choose to use just 20% of battery capacity and save 80% for the next grid failure. African countries for example.

Keep batteries 100% charged:

ESS can also be configured to keep the batteries fully charged. Utility grid failure is then the only time battery power is used - as a backup. Once the grid is restored, the batteries will be recharged either from the grid or from solar panels - when available.

ESS in a system with a generator

Configuring ESS in a system which uses a diesel generator as backup - for extended mains failures - can be achieved. Grid code and Loss of Mains configuration will need special attention, see [here](#).

And on the [GX device](#), select 'Generator' as the AC Input type in the Settings → System setup menu. The system will then enable generator charging; ensure that the generator is properly loaded, and will be automatically switched-off as soon as parameters are met.

When not to use ESS

- Off-grid systems - either with or without generator.
- Marine systems.
- Automotive systems.
- Inverter priority, also known as 'Intentional islanding' or 'Ignore AC' input systems.

With and without grid-meter

ESS can be used both with an external grid-meter, or without one.

Where there is a grid-meter; either a full or partial grid-parallel system can be configured to run alongside.

Where there is no grid-meter; all loads are connected to AC-out. And where there is a PV Inverter

present, that is also connected to AC out.

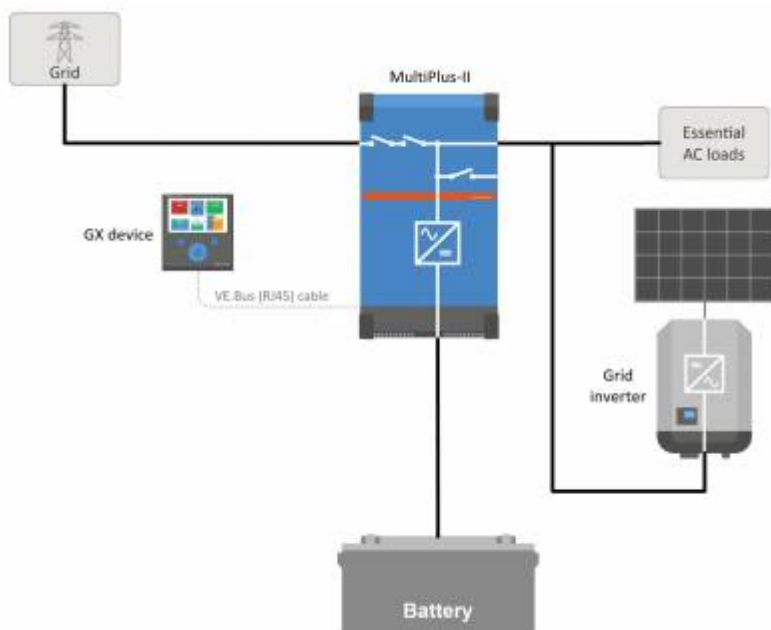

Optional feed-in of MPPT Solar charger power

Power from an MPPT can be fed back to the grid. Enabled/disabled by a user setting on the CCGX: Settings → ESS.

Fronius Zero feed-in option

By using the Power Reduction feature in Fronius grid-tie inverters, the ESS system can automatically reduce the output of the installed PV Inverters as soon as feed-back is detected; without switching and frequency shifting.

It is not possible to combine ESS with the Fronius Smart Meter - but it's not necessary either, as ESS already has metering.

With ESS, it is not possible to disable feed-in a system with other brands of grid-tie inverters. See [Chapter 2.1.2](#) for more information.

ESS Training

- [ESS Webinar 2016-12-19 Youtube \(EN\)](#)
- [ESS Webinar 2016-12-19 Youtube \(DE\)](#)
- [ESS Webinar 2016-12-19 Youtube \(ES\)](#)
- ESS Webinar 2016-12-19 PPT

Energy Storage System introduction, examples and diagrams

A separate document that provides further introductory information, overviews, and system examples is available to [download here](#).

Advanced control options

See [ESS mode 2 and 3](#).

1.1 Let's look at the following example-installations:

- Residential scale Energy Storage System with MPPT Solar Charger
- Retrofitting an existing Grid-tie inverter installation
- System with Generator backup (using the auto genset start/stop feature in CCGX)

Backup system with Solar

All loads are wired on the AC output of the inverter/charger. The ESS mode is configured to 'Keep batteries charged'.

When using a grid-tie inverter, it is connected to the AC output as well.

When grid power is available the battery will be charged with power from both the grid and the PV. Loads are powered from PV when that power-source is available.

Feed-in is optional, and can be enabled or disabled depending on local regulations.

1.2 Components

Inverter/charger

The Energy Storage system, uses a [Multi or Quattro bidirectional inverter/charger](#) as its main component.

Note that ESS can only be installed on Multis and Quattros which feature the 2nd generation microprocessor (26 or 27). All new systems shipped have 2nd generation chips.

GX device

The system is managed by the [Color Control GX \(CCGX\)](#), which also provides extensive monitoring, both locally and remotely via our [VRM Portal](#) and the [VRM App](#).

Battery

[Victron Lithium batteries](#)

- <https://www.victronenergy.com/batteries/lithium-battery-12-8v>
- <https://www.victronenergy.com/batteries/lithium-battery-24v-180ah>

Third-party battery compatibility

Please see this list of third-party batteries with which Victron equipment is compatible:

https://www.victronenergy.com/live/battery_compatibility:start

Lead batteries: OPzS and OPzV

The relatively high internal-resistance of these types of batteries should be taken in to account when designing a system which uses them.

Lead batteries: AGM / GEL

Note that the use of standard AGM and GEL batteries is not recommended for installations designed to cycle the battery bank every day.

Battery Monitor

In most situations, it is not necessary to install a battery monitor:

- Lithium batteries with canbus connection (BYD B-Box, Pylon, LG Resu and others) already have a built-in battery monitor. Adding another will only set up a conflict. Always use the canbus connection to provide battery status/state-of-charge data for these batteries.
- Redflow ZBM / ZCell zinc-bromide flow batteries with the ZCell BMS also support the same canbus protocol. This is the preferred integration approach for these batteries.
- The built-in battery monitor of the Multi Inverter/Charger can be used to provide data where installed batteries do not have a monitor built-in. The advantage here is that in an ESS system the charge currents from MPPT Solar Chargers will also be taken into account.

The only situation where an external battery monitor is required is when a system using a no-monitor battery type also has additional power sources: for example a DC wind generator. (No monitor battery types include lead batteries, for example, or [Victron 12.8V lithium batteries](#).)

Where an additional battery monitor is necessary, use one of these:

- [BMV-700](#)
- [Lynx Shunt VE.Can](#)

Detailed information is available in the [CCGX manual chapter 2.4](#).

Grid Meter (optional)

For a full or partial grid-parallel installation an Energy Meter can be installed in the main distribution panel between the grid and the installation.

A grid meter is not required where there are no AC renewable-energy source(s) and also no AC load(s) present on the the *input* side of the Multi/Quattro system (i.e. where all such sources and loads are on

the *output* side of the Multi/Quattro system).

If there is any AC renewable energy source *or* any AC load between the grid connection point and the input side of the Multi/Quattro system, incorrect results will be calculated and recorded by the GX unless a grid meter is installed and enabled.

In particular, without a grid meter:

- When renewable energy is being provided on the input side, the grid value will be wrong (too low/negative); and
- The AC Load value shown will be too low (and will show zero where there is a surplus of renewable energy).

Both issues are resolved by installing a grid meter.

[Click here for more information about the configuration of grid meters.](#)

PV (optional)

ESS can work with both Grid-tie PV inverters and/or MPPT Solar Chargers. (A mix of both is also possible.)

When using Grid-tie PV Inverters we recommend monitoring is performed using the CCGX. See [CCGX manual](#) for the options.

ESS can also be operated without PV. This is typical for *virtual power plants*, where the installation is part of a cluster of small storage systems - supplying energy to the grid during peak demand.

2. System design

2.1 PV

2.1.1 MPPT Solar Charger and/or Grid-tie inverter

ESS can work with either an MPPT Solar Charger or a grid-tie inverter, and a mix of both.

Generally speaking the MPPT Solar Charger will be more effective than a grid-tie inverter in a small system. The reason for this is that an MPPT Solar Charger is up to 99% efficient ...whereas the PV energy coming from a grid-tie inverter is first converted from DC to AC, and then back from AC to DC, causing losses up to 20 or 30%. This will be even more noticeable when the energy consumption takes place mainly in the mornings and the evenings.

When most of the energy consumption takes place during the day - say in an office with air-conditioning - a grid-tie inverter will be more efficient. After (very efficient) conversion to AC, the PV energy is used directly by the air-conditioning unit.

In the case of 'no Feed-in' consider using an MPPT Solar Charger - or otherwise a Fronius PV Inverter,

and then use the Zero Feed-in function. This will lead to a much more stable system.

2.1.2 Feed-in or no Feed-in

The rules around Feed-in differ all around the world. In various countries:

1. Energy can be sold back to the grid- or to reduce the electricity bill by running in reverse.
2. Feed-in is allowed, but not rewarded: All energy being fed back is lost in the sense that the utility provider will not pay for you it. It is, however, an ecologically-sound power-contribution.
3. Feed-in is absolutely not tolerated - even for a few seconds: there are certain prepaid meters in South-Africa that will disconnect from the grid when they detect Feed-in.
4. Feeding-in results in inflated bills because the electricity meter can only count in one direction - up. Every kWh fed-back to the grid is erroneously counted as energy used, and will be charged for.

Feed-in

Feed-in of PV power via an MPPT Solar Charger can be *enabled* or *disabled* in the Energy Storage Systems menu on the CCGX. Note that when disabled, the PV power will still be available to power AC loads.

Feed-in of PV connected to grid-tie inverters occurs automatically. There are no settings or special design considerations to be considered whether connected on the *input* and/or *output* of the inverter/charger.

No feed-in

Feed-in of PV power via an MPPT Solar Charger can be *enabled* or *disabled* in the Energy Storage Systems menu on the CCGX.

For grid-tie inverters, the only option is to use a *Fronius* grid-tie inverter and use the Fronius Zero Feed-in function. See chapter [2.1.3](#).

Using other brands of grid-tie inverters in a No-feed-in system is not recommended. With ESS it is not possible to prevent feed-in where other brands are installed. And using the Hub-2 Assistant as an alternative method leads to a less-than-perfect installation. There can be problems with flickering lights - or even a whole-system shut-down, through overload, when a large load is switched on or off.

2.1.3 Fronius Zero Feed-in

For Fronius grid-tie inverters ESS has a special feature: Zero feed-in.

With the Zero feed-in option enabled, the ESS system will continuously monitor and actively control the output power of the Fronius grid-tie inverter. See chapter [4.3.11](#) for detailed requirements and settings.

2.1.4 MPPT Solar Chargers

All Victron MPPT solar chargers can be used: both the models with a VE.Direct port as well as the models with a VE.Can port.

2.1.5 Grid-tie inverter in parallel or on AC out?

There are two options when connecting the grid-tie inverter:

- in parallel with the Multi or Quattro.
- on the AC out.

When connected on the AC out, the [factor 1.0 rule](#) must be adhered to. There are no exceptions to this. Also use the factor 1.0 rule in countries where the utility grid rarely fails; and also when connecting a Fronius grid-tie inverter on the AC out, and employing 'Zero feed-in'.

2.2 Battery bank capacity

In a grid-parallel system, the size of the battery bank has these effects:

- Small batteries will be more cost effective: but all available storage capacity is used every day
- Small batteries will be charged and discharged with high currents. This will cause lead batteries, in particular, to have a shorter life.
- Larger batteries, combined with a relatively large PV installation, can store excess power on sunny days. Power might then be available during several consecutive days of poor weather.
- Larger batteries provide longer autonomy during a power outage. When the installation is required to operate as an *Uninterrupted power supply* a large battery capacity provides secure power provision for longer periods.

In a backup system, the battery size is calculated by the required autonomy during a mains failure.

See [AC-Coupling minimum battery capacity](#) for minimum battery sizes of systems with a grid-tie PV Inverter connected on the AC output of the Multi(s) or Quattro(s).

2.3 Inverter/charger size

The required size of the inverter/charger depends on the type of installation.

In a grid-parallel installation, the size of the inverter/charger can be (much?) smaller than the highest expected nominal and peak loads. For example, to cover the base load of a two-person household, an 800VA inverter/charger may be sufficient. For a family, a 3000VA inverter/charger can run most appliances - as long as not more than one of them is running at the same time. This means that the system can reduce grid power consumption from late spring to early autumn - perhaps to zero - with sufficient storage.

In a backup installation, the inverter/charger needs to be sized according to the expected loads.

2.4 Anti-islanding

ESS always requires anti-islanding. This is also true for a No feed-in-system.

For several countries the built-in anti-islanding in our products can be used. For example the MultiGrid in Germany, and the MultiPlus in the United Kingdom. See certificates on our website for details.

In case there is no certified product available for the country of installation, install external anti-islanding.

More details here: [VEConfigure: grid codes & loss of mains detection](#).

3. Installation

Follow the instructions in the manuals of each component for its correct installation.

When installing a *single-phase* ESS in a system with a *three-phase* connection to the utility grid, make sure you install the ESS on phase one, L1.

Temperature-compensated charging

Multi, MultiPlus, MultiGrid or Quattro

Connect the temperature sensor supplied with the device. In the case of installations with multiple units in parallel, and/or dual- or three-phase configurations, the temperature-sense wire can be connected to any unit in the system. For more information, see the [Parallel, split- and three-phase VE.Bus systems](#).

The Multi will, of course, use the measured battery temperature for temperature-compensated charging. It will also do this when charging with power coming from a grid-tie PV Inverter ...whether connected to mains, or - in case of a mains failure - with solar power coming from a grid-tie PV Inverter when that inverter is connected to the output.

Solar chargers

Solar chargers will automatically use the information from the Multi or Quattro for temperature-compensated charging as well. Both VE.Direct Solar chargers and VE.Can Solar chargers.

Voltage-sense wiring

Multi, MultiPlus, Multi Grid and Quattros: wire the voltage-sense according to the instructions in the manual.

VE.Direct solar chargers: there is no voltage-sense option: no voltage sense is used.

VE.Can solar chargers: connect a voltage-sense wire to one of the solar chargers in each 'sync' group.

4. Configuration

4.1 Update to latest firmware

Update all components to the latest firmware version:

1. Venus-OS v2.15 or newer. Instructions to upgrade to v2.00 can be found [here](#).
2. Multi, MultiGrid, MultiPlus or Quattro to 422 or newer. Instructions [here](#).
3. Solar Chargers, either VE.Can or VE.Direct must run their latest firmware version.

For firmware files and instructions, see the Firmware section in [Victron Professional](#).

4.2 Multi/Quattro and ESS Assistant

Settings to be made in VEConfigure:

1. Grid tab: configure the country code. A password is required: ask your supplier. More information in [VEConfigure: grid codes & loss of mains detection](#). **Note:** If you leave this setting as 'None', the system will not supply battery energy to support local AC loads when the grid is connected. You *do* need to change this setting even if it is your intention *not* to export DC energy to the grid.
2. Add the ESS Assistant. Instructions on how to add an Assistant [here](#).
3. General tab: the ESS Assistant will have enabled the built-battery monitor. Leave that enabled (!). Also when there is a BMV or intelligent canbus-connected battery in the system.
4. Charger tab: the ESS Assistant will have already selected the proper battery type, as well as disabled the Storage mode. Verify and where necessary change the rest of the settings: charge voltages & maximum charge current. Note that, for systems with the ESS Assistant installed, the MPPT Solar Chargers will follow the charge curve as set in VEConfigure. The charge parameters configured in the MPPT Solar Chargers are ignored in an ESS setup.
5. Configure all the other settings.

Notes with regards to the Input current-limit and PowerAssist:

- Input current-limiter setting - The configured limit is used as the threshold for AC current at the AC-in of the Multi/Quattro. Further notice that:
 - Loads in parallel with the Multi/Quattro are not taken into account: therefore, install all loads on the AC-out of the Multi or Quattro in systems that require AC Input Current limiter functionality. For example - systems with a small AC load connected.
 - The current limiter will be used for both directions of the current.
 - The PowerAssist setting in VEConfigure3 will be disabled and ignored when ESS is installed.
- The Dynamic current limiter in VEConfigure3 will be disabled and ignored when ESS is installed.

Notes relating to Low battery warning levels:

- The low battery warning is active when the battery voltage drops below the dynamic cut-off level plus the restart offset, which defaults to 1.2 Volt for a 48V system. Just like the cut-off voltage, the warning voltage level is also dynamic.

- There is no hysteresis: the warning will disappear when the voltage rises again.
- During this warning, also called a pre-alarm, the red LED on the Multi will blink, and optionally CCGX will show a notification. For most ESS systems its recommended to disable that notification on the CCGX. See FAQ below.
- The related parameters on the Inverter tab, ie. the DC input- low shut-down, restart and pre-alarm levels do not apply. They are ignored when the ESS Assistant is installed.

General notes:

- PV power coming from a grid-tie inverter, either connected in parallel on the AC out, will be used to charge the battery. Charge current and other charge parameters are configured on the Charger tab in VEConfigure3.
- Make sure to keep the lithium batteries checkbox on the charger page consistent with the battery choice in the Assistant.
- When using a VE.Bus BMS and a Multi Compact, check the DIP switches: DIP switch 1 must be on, and DIP switch 2 must be off.

4.3 GX device - ESS Settings

Navigate to Settings → ESS, to see this menu:

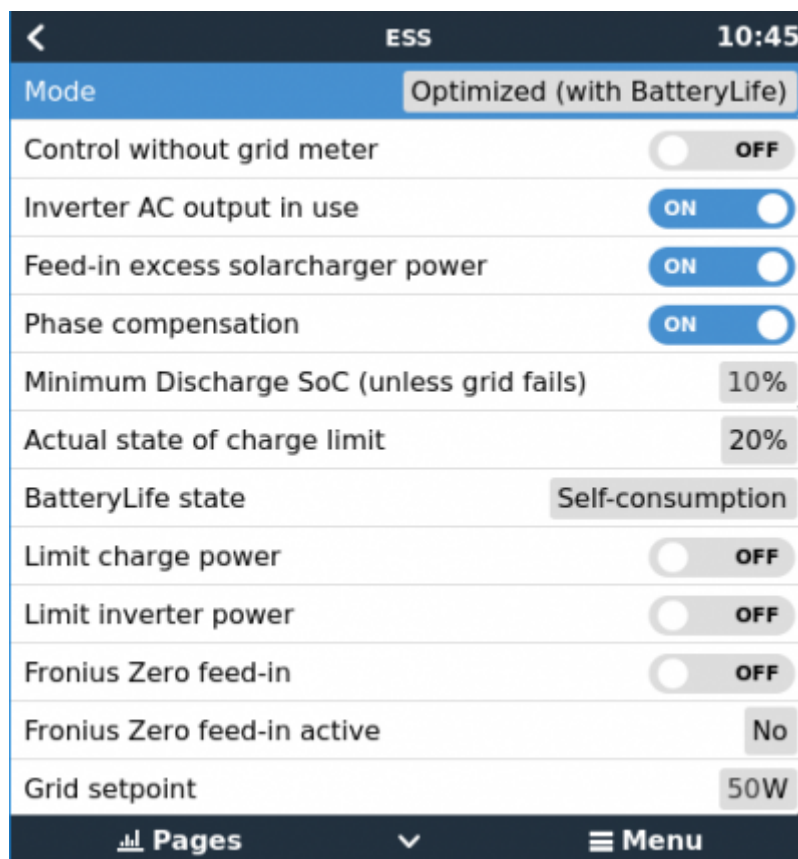

4.3.1 Mode

Optimized (with BatteryLife) and Optimized (without BatteryLife)

At times when there is excess PV power, the PV energy is stored in the battery. That stored energy is

then used later, to power the loads at times when there is a shortage of PV power.

Keep batteries charged

Failures of the utility grid are the only periods at which the battery will be discharged. Once the grid is restored, the batteries will be recharged with power from the grid, and of course also solar, when available.

External control

The ESS control algorithms are disabled. Use this when self-implementing a control loop. [More information](#).

BatteryLife

For details on BatteryLife operation, [see Chapter 6.2](#). In short, enable BatteryLife for these technologies:

- OPzV, OPzS
- GEL / AGM
- Victron 12.8V Lithium batteries, and other lithium batteries that have passive cell balancing

Because it makes no sense to leave a battery discharged, without reserve power in case of mains failure, we recommend leaving BatteryLife enabled for systems using Lithium with active cell balancing, however it *can* be disabled in this case.

Redflow specifies that BatteryLife should be disabled in [Redflow ZCell](#) installations, because the ZCell battery can rest at zero SoC without damage for an unlimited period, and also because the BatteryLife function conflicts with the ZCell battery maintenance cycle.

4.3.2 Grid meter installed

Leave Off when no Victron grid meter is installed, and set to 'On' when such meter is installed.

All loads and (optional) grid-tie inverters must be installed on the AC out in a system without a Victron grid meter. See earlier in the manual for more information.

4.3.3 Inverter AC output in use

Setting this to 'Disabled' hides the AC-out graphic in the overview pane. Use this in systems where there is nothing connected to the output of the Multi or Quattro, which is typical for certain grid-parallel systems in Western Europe.

4.3.4 Feed-in excess solar charger power

Set to 'On' to make the Solar Charger always operates at its maximum power point. The first priority is powering the loads, and the second priority is to charge the battery. If more power is available when those two priorities are met, then that power will be fed to the utility grid.

Please note that when enabling this option, the DVCC charge current limit configured under Settings → Limit charge current won't be active. The Solar charger will operate at full power for maximum feed-in into the grid. It's advisable to configure a safe limit on the solar chargers when used with a small battery bank.

4.3.5 Phase compensation

See [see chapter 7](#).

4.3.6 Minimum Discharge SOC (unless grid fails)

Configurable minimum SOC limit. Either with or without BatteryLife enabled, ESS will drop loads once the SOC has fallen to the configured setting - except when the utility grid has failed and the system is in Inverter mode. In this case it will continue discharging the battery until one of the other thresholds have been met. See [chapter 6.1](#) for more information.

4.3.7 Actual state of charge limit

(Applies only when BatteryLife is enabled)

This % shows the maximum usable capacity of the system - which will never be more than 80%.

Use this setting to see the current BatteryLife SOC level.

4.3.8 BatteryLife state

The different BatteryLife states are:

- *Self-consumption*: normal operation - discharging allowed.
- *Discharge disabled*: the battery has been discharged to the actual SOC limit. (The state will return to *self-consumption* whenever the SOC rises 5% above the set limit).
- *Slow charge*: ESS will slowly charge the battery when the SOC has been below the actual SOC limit for more than 24 hours. It will keep slow charging until the lower limit has been reached at which point the system once again switches to *Discharge disabled*.
- *Sustain*: the Multi/Quattro has gone into sustain mode after the battery voltage has reached the dynamic cut-off voltage during discharge.
- *Recharge*: ESS will recharge the battery to the minimum SOC limit if it drops more than 5% below the minimum configured SOC. Once the minimum SOC is reached the system once again switches to *Discharge disabled*.

4.3.9 Limit charge power

This setting limits the amount of AC power used by the Multi for battery charging. The limit also applies to AC power received by the Multi from any grid-tie PV Inverters connected to AC-in.

In other words, this setting limits the flow of power from AC to DC on utilities connected to AC-in.

- This setting does not reduce the charge power coming from *MPPT Solar Chargers*.
- This setting only applies to utilities connected to AC-in: In inverter mode, the 'charge-current setting' - as configured in VEConfigure - is used to control power coming from grid-tie PV Inverters.

4.3.10 Limit inverter power

Limit the power drawn by the Multi: ie. limit the power being inverted from DC to AC.

Notes:

- The losses in the inverter/charger are *not* taken into account. If you want to limit the amount of power being drawn from the battery, you will have to set this limit slightly lower to compensate for those losses.
- Power coming from the MPPTs is not taken into account. Using this feature in a system with MPPTs can cause the output power from the MPPT to be reduced.
- This limit is with respect to power drawn from the battery and will affect the total of all phases.
- This limit only applies while connected to AC-in: In inverter mode, the AC loads determine how much power is drawn from the battery.

4.3.11 Zero feed-in (Fronius PV inverters only)

- The earliest Fronius firmware version which can be used is 3.7.3-2
- If there is more than one Fronius PV Inverter present in the system, they will all be limited
- Zero feed-in is not supported on Fronius IG Plus inverters.

Change the following settings in the Fronius web interface:

- In the Fronius setup menu, set Data export via Modbus to tcp.
- In the same menu, set Sunspec Model Type to int + SF
- In Settings→DNO Editor, make sure dynamic power reduction is set to No limit (this is the default).
- In Settings→DNO Editor, make sure that in the 'Controlling Priorities' section that 'Controlling via Modbus' is set to be priority 1.



Use the [Fronius Zero feed-in active](#) menu item to double check that all above criteria are met. It will show **No** if the firmware requirement; the Data export; or the Sunspec Model type settings are incorrect.

Do not use a Fronius Smart Meter for limiting export when part of a Victron ESS System. More details about when a Fronius Smart Meter can, and can not be used is explained [here](#).

4.3.12 Grid setpoint

This sets the point at which power is taken from the grid when the installation is in self-consumption mode. Setting this value slightly above 0W prevents the system from feeding back power to the grid when there is a bit of over-shoot in the regulation. The default value is therefore 50W - but should be set to a higher value on large systems.

4.4 GX device - Scheduled Charging

4.4.1 Introduction

The Scheduled Charging setting is located in the ESS menu of the [GX device](#). It allows you to set up to five scheduled periods, during which the system will take power from the grid to charge the battery. This is typically used to charge the battery during off-peak tariff time windows (TOU). For each schedule, configure a start-time, duration, and optionally set the percentage up to which you want the battery to be charged.

If the target state of charge is reached, and it is still within the period of time set, the battery will stop charging but will not discharge (unless there is grid outage). This optimises battery cycling and still allows room in the battery for PV charging.

4.4.2 Configuration

Scheduled charging is available as part of ESS. It is accessible on the [GX device](#) menus under Settings → ESS. It is only available when the ESS mode is set to Optimised. Scheduled charging naturally makes no sense when the mode is set to Keep Batteries Charged.

You can see at a glance what is configured, with a summary of the start day, time and duration shown for each.

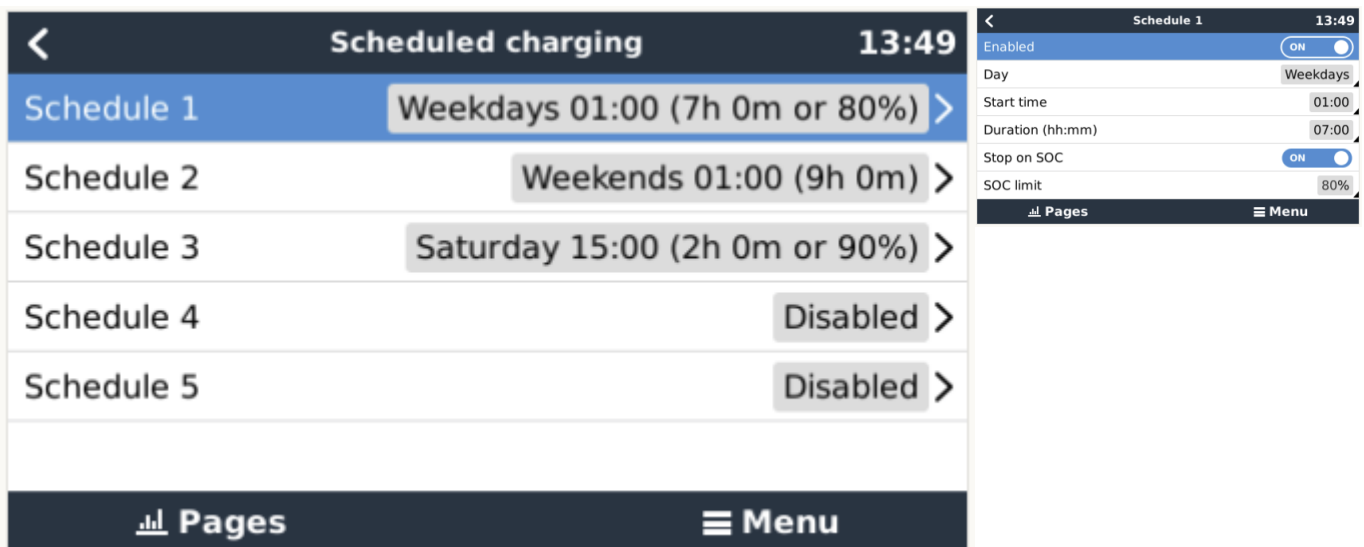

For each schedule you can select a specific day of the week, every day of the week, or you may opt to charge on all weekdays or only on weekends.

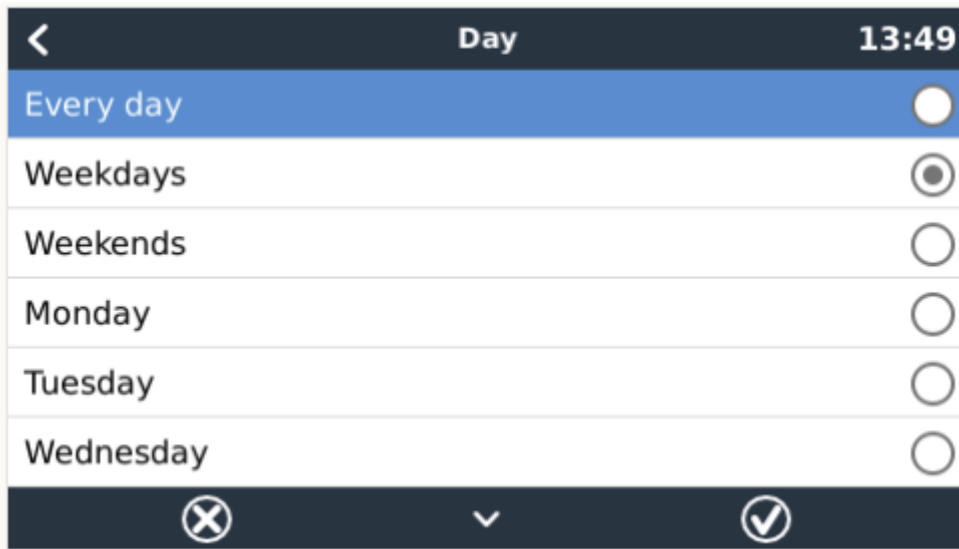

The Multi will start charging from the grid at the specified start time, and stop after the set duration or when the set SOC limit is reached. The period designated by the day, start time and duration will subsequently be referred to as a scheduled charge window.

During charging, the ESS state will indicate that Scheduled Charging is in progress.

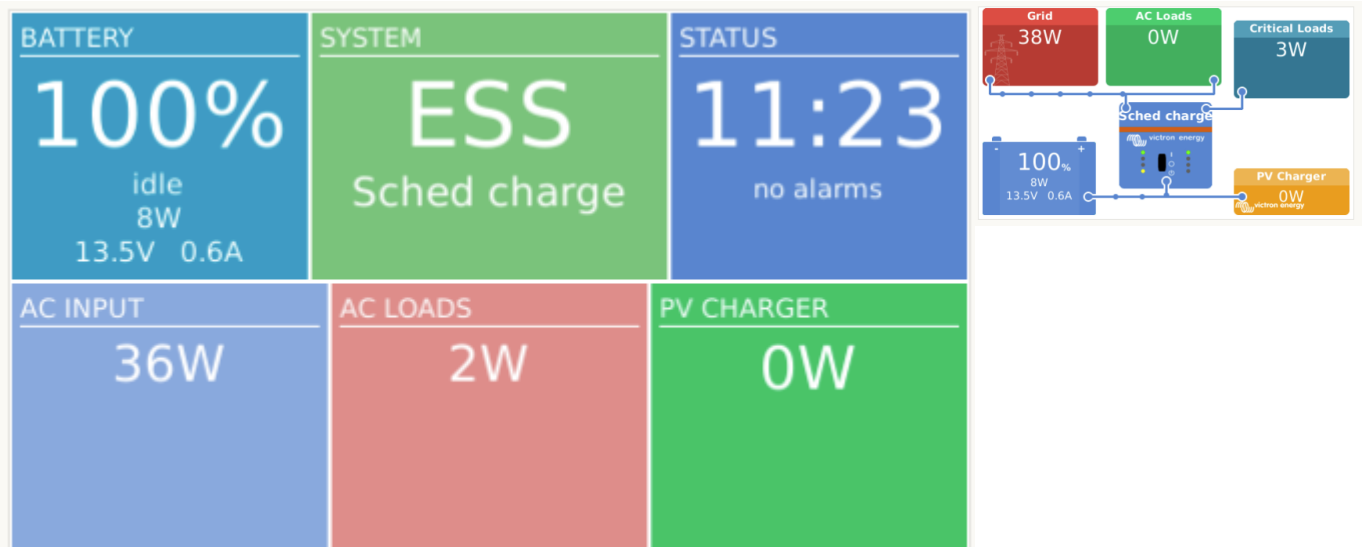

4.4.3 Stop charge on SOC

When a SOC limit is set for a scheduled charge window, charging will stop when the batteries reach the requested SOC. The batteries will however not discharge until the scheduled charge window ends. The goal is to be at or near the requested SOC at the end of the scheduled charge window.

4.4.4 Frequently asked questions

Why does the Multi not discharge the battery after charging ends?

Discharge is disabled until the end of the scheduled charge window. The goal is to exit the window at the requested SOC.

How can I prevent discharge to reserve battery capacity for later in the day?

Set a charge window for the required period with a low SOC Limit. Discharge is disabled in a scheduled charge window.

What happens if I set overlapping schedules?

The first matching schedule takes priority. If the two schedules have different SOC limits, the limit of the second matching scheduled charge window takes effect after the first scheduled charge window ends.

4.5 GX device - Other settings

4.5.1 Settings -> System setup -> AC Input types

Set the AC Input type to *Generator* when connected to a generator. The system will then enable generator-charging and correctly load the generator when running.

Note that we recommend wiring the Generator to AC-in 1, and the Grid to AC-in 2. The reason is that the Quattro will then prioritize the Generator over the Grid. That arrangement offers maximum flexibility (allowing forced generator intervention even when the grid is available) and maximises control.

4.5.2 Settings -> Generator start/stop

More information on controlling remote generator start/stop is available [here](#).

4.6 MPPT Solar Charger

In ESS, the MPPT Solar Chargers will follow the charge curve as set in VEConfigure. The charge parameters configured in the MPPT Solar Chargers themselves are ignored in an ESS setup.

The *Charge current*, however, still needs to be configured in the MPPTs.

MPPT with VE.Direct comm. port

No special configuration is necessary.

MPPT with VE.Can comm. port

No special configuration is necessary. Make sure the *Device instance* is configured to 0 (the default). MPPTs in the VE.Can network configured to a different *Device instance* will not be managed by ESS.

5. Commissioning

MPPT Solar Chargers

The MPPT state - as shown on the CCGX to which it is connected - will show 'ESS'.

The blue 'Bulk' light on the MPPT will be lit and occulting every four seconds to indicate that the MPPT is remotely controlled.

Installations using a Grid Meter

'Grid Meter' will be visible in the *Device list* of the CCGX

Optimize mode

- Switch off or disconnect all loads. When power from PV is available the battery status will show *Charging*, and the Grid (the red box on the left of the overview) will be slightly fluctuating around 0W (zero watts).

Keep batteries charged mode

After configuring this item, the system will immediately start charging the battery.

Take these steps to verify operation:

1. First, disconnect the mains. The system will switch to inverter mode and power loads from the batteries, and also directly from PV.
2. Then reconnect the mains. The battery will be charged from both the mains and from PV.

Fronius Zero feed-in

In the Settings → ESS menu, the Zero feed-in active item shows 'Yes'.

Backup Generator

Start the generator and check that the system begins to charge the batteries.

6. Controlling depth of discharge

(Note: All absolute voltages mentioned in the example below refer to a 12V system. Voltages should be multiplied by x2 or x4 for a 24V or 48V system, respectively.)

6.1 Overview

Mains present

When there is less PV power available than is required to power the loads (at night for example), energy stored in the battery will be used to power the loads. This will continue until the battery is depleted (ie. has reached its user-defined minimum % SOC).

When mains power is available, any one of the following three parameters will inform the system that the battery-storage has been depleted:

1. Battery State of Charge: Minimum SOC as configured in the CCGX has been reached. When set to 60%, all capacity between 60% and 100% will be used to optimize self-consumption. And 0% to 60% will be used in case of a mains outage. Note that the minimum SOC parameter - as configured in the CCGX - may be amended on a daily basis by the [BatteryLife algorithm](#).
2. Battery Voltage. See [Dynamic Cut-off section](#), further down below.
3. Low cell signal from a BMS:
 - Victron VE.Bus BMS
 - 3rd party Canbus enabled BMS

Mains outage

When no mains power is available, and the system is in inverter mode, the following parameters control the depth of discharge:

- Dynamic cut-off
- Low cell signal from the VE.Bus BMS is still active
- Low cell signals from 3rd party canbus enabled BMS's are ignored. The system relies on the automatic protection inside Lithium cells to trip.

What about the Sustain mode?

The Sustain voltages have no effect on *when* the system stops discharging the battery: Sustain is activated only after the battery has been flagged as empty. See [Sustain](#) section below for more information.

6.2 BatteryLife

What does BatteryLife do?

The *BatteryLife* feature prevents a harmful 'low battery state-of-charge' from being allowed to continue for an extended period of time. For example in winter, if there is insufficient PV power available to replace the stored battery energy which is consumed every day, without the *BatteryLife* feature the battery SOC will fall to its low-limit and stay at or near that level - continually failing to become fully-charged.

BatteryLife tries to ensure that the battery will always be recharged to 100% SOC - every day. This is how it works:

During periods of poor weather when Solar energy is reduced, *BatteryLife* will dynamically raise the

Low SOC limit which has been set. This has the effect of making less power available for consumption. It raises this level by 5% each day until the energy which the system draws from the batteries during a 24hr period matches the energy being replaced. The aim is for the battery to operate at or near 100% SOC.

When weather conditions change, and more Solar energy becomes available, the system will once again lower the *Low SOC limit*, day by day, making more battery capacity available for use (it will eventually return to the user-preset limit) - whilst still ensuring that the battery SOC ends each day at or close to 100%.

The strength of this feature becomes apparent when you ask yourself, "Why should the battery be allowed to remain fully discharged for long periods of time, leaving no reserve power in case of mains failure ...and with the possible result of damaging the battery?".

Details

This feature has several advantages:

- Operating around a low state of charge shortens the life of lead/acid batteries.
- Certain lithium batteries also need to be fully charged regularly in order to balance their cells. This includes the [Victron 12.8V lithium batteries](#), for which it is mandatory to enable *BatteryLife*.
- In case of mains failure - having no spare energy available from the batteries to power the loads defeats the whole purpose of having a battery back-up.

If the battery SOC falls below the SOC *low-limit* for more than 24 hours, it will be slow-charged (from an AC source) until the lower limit has been reached again.

The dynamic *low-limit* is an indication of how much surplus PV power we expect during the day; a low-limit indicates we expect a lot of PV power available to charge the battery and that the system is not expected to discharge more energy at night than it receives the following day.

The graph below shows two identical systems - one (the blue line) is using the *BatteryLife* feature; the other (the red line) isn't. It's spring, and the battery *state of charge* for each system is graphed for one week. As the week progresses and more solar energy is becoming available, notice how *BatteryLife* makes it's system operate at or near full charge, and how it allows the depth of discharge to be increased as the solar power harvest increases. Notice, too, the red line which shows what happens without *BatteryLife*.

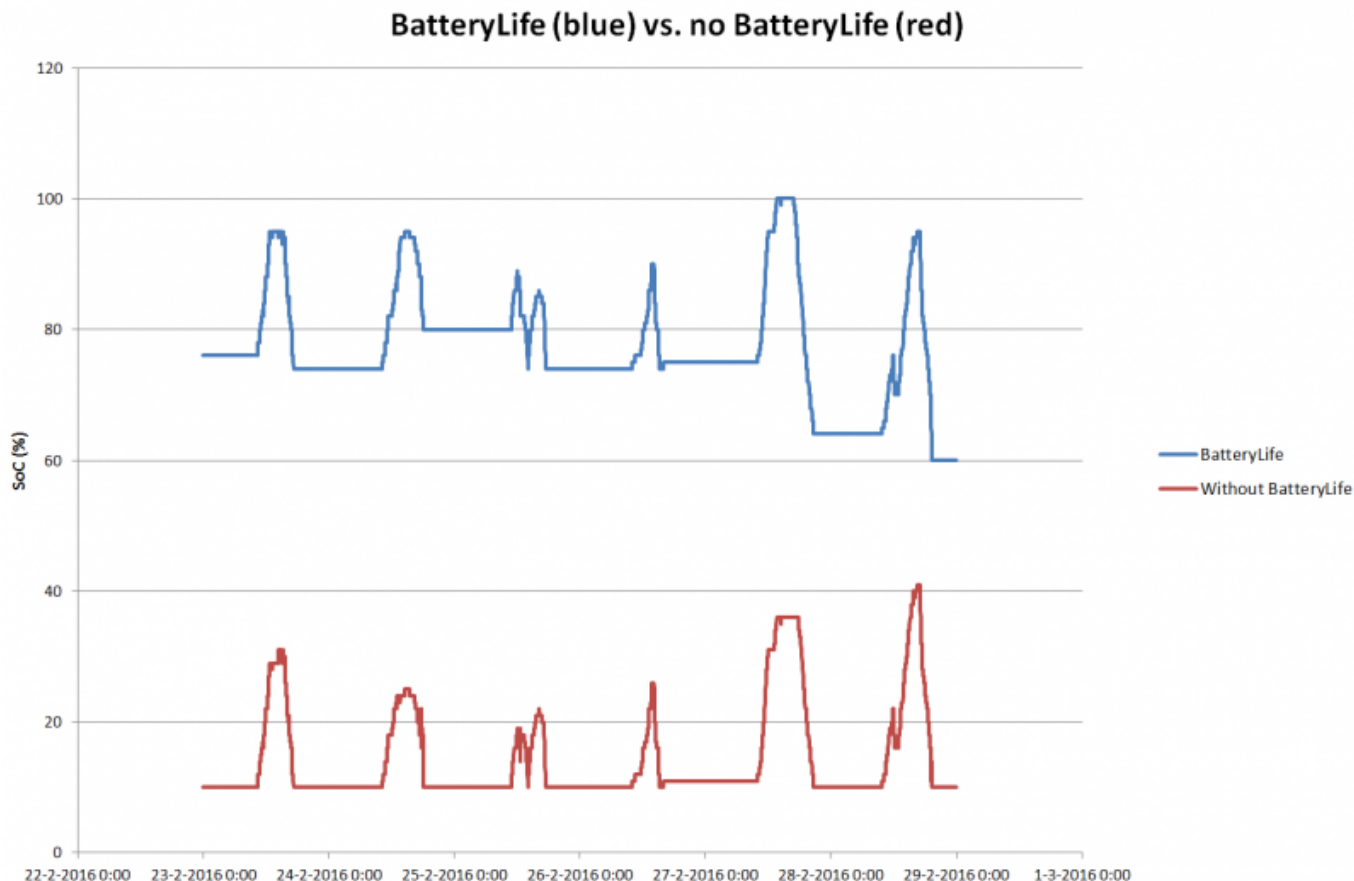

Technical details

On a technical level, BatteryLife increases the dynamic lower charge limit by 5% for each day that a good state of charge was not reached. The value is increased once a day when the battery reaches the lower limit for the first time. When the battery reaches 85% SoC on the day, the increment for that day is canceled and the limit remains the same as the previous day. If the battery reaches 95% on any day, the dynamic discharge limit is lowered by 5%. The result is that the battery reaches a healthy charge of between 85% and 100% SoC every day.

6.3 Dynamic Cut-off

The Dynamic Cut-off feature works 'intelligently'. Instead of merely cutting off loads when a low-voltage threshold has been reached, it takes into account the amount of *current* being drawn from the battery. When the current being drawn is high, the shut-down voltage might be 10V, for example; whereas if the current being drawn is a small one, the shut-down might be 11.5V.

This compensates for the internal resistance in the battery, and makes *Battery Voltage* a much more reliable parameter to indicate whether a battery is becoming critically discharged.

The graph below shows the default 'Discharge' vs. 'DC input low shut-down voltage' curves for different battery types. The curve can be adjusted in the assistant.

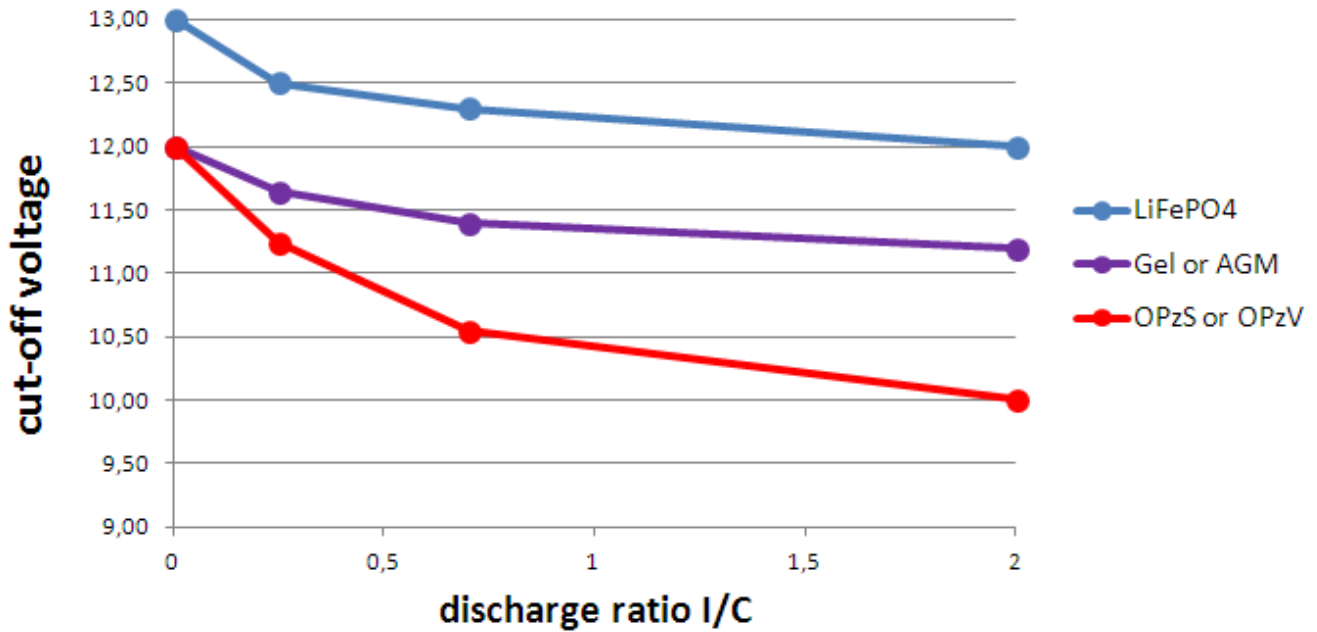

Notes:

- Dynamic cut-off is useful for batteries with a high internal resistance. For example OPzV and OPzS; but is less relevant for LiFePO4 batteries because of their low internal-resistance. See how the graph shows a much flatter curve for the charge current vs disconnect voltage.
- None of the three DC input low parameters (-shut-down, -restart and -pre-alarm) on the Inverter tab are operative. They are overridden by the Dynamic cut-off levels, together with the restart levels - which are all configured in the ESS Assistant.
- The Dynamic cut-off mechanism effective both when mains is available *and* during a mains-failure (system is in Inverter mode).

6.4 Sustain Mode

Sustain Mode prevents the damage caused by leaving batteries in a deeply-discharged state.

Sustain Mode is entered after the battery has been flagged as discharged, and the two conditions which trigger it are:

- When the battery voltage has fallen below Dynamic cut-off
- A Low-cell signal from the VE.Bus BMS

While Sustain is active, the battery voltage will be maintained at the *sustain-voltage-level* - which is set at:

- Lithium batteries: 12.5V
- Other batteries: 11.5 V for the first 24 hours, and after that it is raised to 12.5 V

When the battery voltage has fallen below the sustain level it will be charged back up to the *sustain-voltage-level* using power from the grid. The charger will ensure that voltage level is maintained - using power from the grid when necessary. The maximum charge current it uses for this is 5 Ampère per unit. (5 A applies to all installations - regardless of system voltages (12 / 24 / 48 V).

Excess solar power will also be used for battery charging.

Sustain mode is exited when solar-charging has been able to raise the battery voltage 0.1 V above the *sustain-voltage-level*. Normal operation will then continue - with the battery providing power when insufficient energy is harvested from the PV array.

(This 0.1 V is the threshold for 12 V systems; for 24 V the threshold is 0.2 V above; and for 48 V it is 0.4V above.)

6.5 ESS Battery Status Reason Code Numbers

In addition to the charger states (Bulk/Absorption/Float), there are additional Discharging and Sustain codes that provide at-a-glance information on the Pages Overview of GX display.

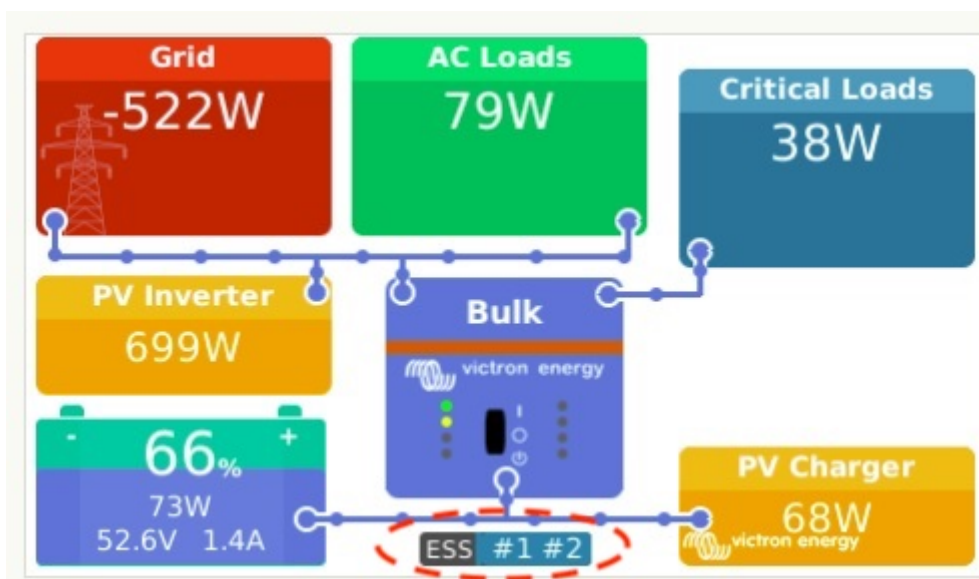

The key for these codes is:

- #1: SOC is low
- #2: BatteryLife is active
- #3: BMS disabled charging
- #4: BMS disabled discharge
- #5: Slow Charge in progress (part of BatteryLife, see above)
- #6: User configured a charge limit of zero.
- #7: User configured a discharge limit of zero.

7. Phase compensation - further information

7.1 Introduction

Use the Phase compensation setting in systems with a three-phase connection to the utility grid. The setting defines how the ESS interacts with the different phases.

When enabled (default), ESS balances the total power (L1 + L2 + L3) to zero Watt. When disabled,

ESS balances each phase separately to zero.

For single phase systems, this setting has no effect - whether 'enabled' or 'disabled'- and can therefore be ignored.

When the ESS mode is set to *Keep batteries charged*, this setting has no effect.

Single phase connection to the utility grid

- Phase compensation setting has no effect and can be ignored.

Single phase ESS in a system with a three-phase connection to the utility grid

Single phase ESS is a single inverter/charger.

- Phase Compensation enabled: ESS regulates total power L1 + L2 + L3 to 0.
- Phase Compensation disabled: ESS regulates only the power of L1 to 0.

Three phase ESS in a system with a three-phase connection to the utility grid

Three phase ESS is, at least, three inverter/chargers: one on each phase.

- Phase Compensation enabled: ESS prevents circumstances where the battery might be charging on one phase whilst discharging on another.
- Phase Compensation disabled: ESS regulates each separate phase to 0 W. This may result in ESS discharging on one phase whilst charging on another, which is very inefficient.

7.2 Single phase ESS in a three-phase system

With Phase compensation enabled, the (single phase) ESS uses the battery to balance the combined power of all phases to 0 W (zero watts).

See the following example: ESS is connected to L1, and by compensating for phases L2 and L3 as well, it regulates the total power at the distribution panel to 0 W.

	L1	L2	L3	Total
Load	100 W	400 W	200 W	700 W
ESS	-700 W	0 W	0 W	-700 W
Distribution box	-600 W	400 W	200 W	0 W

With Phase compensation disabled, the (single phase) ESS uses the battery to balance only L1 to 0 W. L2 and L3 are visible on the CCGX, but not used by the ESS in any way.

(Make sure you install the ESS on L1. If it's installed on another phase the visualisation will be wrong.)

7.3 Three-phase ESS

A three-phase ESS system has at least one Multi installed on each phase. We recommend leaving the phase-compensation setting to its default: enabled.

Installation details

- The Multi's need to be configured as a three-phase system. Use VE.Bus Quick Configure or VE.Bus System Configurator for this.
- Install the ESS Assistant in all units ...all the phase-masters **and** also all slaves (if any).
- Three phase loads: it is possible to connect three-phase loads to the AC-out of the Multi's. Those loads will be powered from the battery during a power failure.

Phase compensation enabled (default & recommended)

ESS balances the total power (L1 + L2 + L3) to 0 W.

Intelligent optimization of the balance between the phases

ESS intelligently optimizes the balance between the phases - as far as possible. While doing so, it will never charge on one phase whilst discharging on another. To better understand how it works, read these examples closely:

When the phases are in balance the situation is simple. Let's say each phase is consuming 500 W, and only a small amount of PV power is available - 100 W on each phase. Each phase requires another 400 W ...a total of 1200 W for all three phases. So 400 W will be drawn from the battery on each phase, and the draw from the grid will therefore be 0 W. Each separate phase will also be at 0 W.

When the phases are *not* in balance, it becomes more complicated:

In the example below the PV is exceeding the loads on L1 by 1300 W. L2 and L3 have loads of 200 W on each phase. Looking at the sum of all three phases: the house is selling 900 W to the grid - or in an ESS configuration 900 W is available to charge the batteries.

A simple strategy could be to distribute this 900 W of excess power over all the phases and charge the battery with 300 W on each phase:

	PV + Load	ESS	On the meter
L1	-1300 W	300 W	-1000 W
L2	200 W	300 W	500 W
L3	200 W	300 W	500 W
Sum	-900 W	900 W	0 W

The table shows that this is not optimal: the system is now selling on L1, yet buying on L2 and L3, while as a whole it's buying power.

Another solution could be to match each phase. In other words, regulate each single phase to 0 W: charge on L1 with 1300 W, and discharge L2 and L3 each with 200 W. This situation, too, is not optimal: 1700W of power is being converted from AC to DC and back again - yet only 900W is required to keep the total power to 0W . That means 800 W is being needlessly converted, resulting in unnecessary system losses.

	PV + Load	ESS	On the meter
L1	-1300 W	1300 W	0 W
L2	200 W	-200 W	0 W

	PV + Load	ESS	On the meter
L3	200 W	-200 W	0 W
Sum	-900 W	900 W	0 W

(Note that this is what happens when the Phase compensation setting is disabled)

Then the last solution: when the balance of the total system is positive, ie. producing energy, the battery will be charged by the phases which are producing energy. The reverse is also true: when the system as a whole is using energy, the battery will be discharged onto the phases which are using energy. In the present example this means that the battery is charging on L1, with 900 W:

	PV + Load	ESS	On the meter
L1	-1300 W	900 W	-400 W
L2	200 W	0 W	200 W
L3	200 W	0 W	200 W
Sum	-900 W	900 W	0 W

Phase compensation disabled

ESS balances the power of each separate phase to 0 W.

Beware: using the system this way causes significant losses as power will flow from one AC phase to another via the DC connections. This incurs losses caused by converting from AC to DC on one phase, and then back again from DC to AC on the other phase.

Note on the maximum charge current

In a multi-phase system, the charge current is configured *per phase* - rather than for the whole system. A limitation of this arrangement, for example, is where a relatively small battery bank is installed, and at a certain moment a significant over-supply of PV power is available on L1 - but not on the other phases, then only a part of that excess PV power on L1 will be used to charge the battery.

8. Comparison to Hub Assistants

The Hub-1, Hub-2 and Hub-4 Assistant are deprecated in favor of the ESS Assistant. See below for details.

8.1 Hub-1 Assistant -> ESS Assistant

Policies

Hub-1 policies that are deprecated in favor of ESS:

- Policy 1: Connected to mains, feedback: Use ESS and enable solar charger feed-in.

- Policy 2: Keep batteries charged: Use ESS, select the “Keep batteries charged” mode. And enable “Feed-in excess solar charger power”
- Policy 4: Prevent feeding energy to the grid: There are two options here; first - use ESS, but do not enable Solar charger excess feed-in and it will always be connected to the grid. Or, use the Virtual Switch with *ignore AC-Input*.
- Policy 5: Connected to mains, no feedback: Use ESS, select the “Keep batteries charged” mode.

The notes above leaves one policy where the Hub-1 Assistant can do things which ESS cannot:

- Policy 3: Disconnect from the mains when possible: For this either keep Hub-1 Assistant or (which is often a simpler and better solution): use the Virtual Switch with *Ignore AC-Input*.

Load shedding feature: deprecated

Loadshedding is a feature in Hub-1 that is not often used, and therefore has not been implemented in the ESS Assistant. Instead of sticking to Hub-1 - which we do not recommend or support(1) - consider using other options.

For example *misusing* the generator start/stop function in CCGX.

8.2 Hub-2 (v3) Assistant -> ESS Assistant

Comparison per Hub-2 Policy

- Disconnect at night: disconnecting at night is not possible with the ESS Assistant, but in any case disconnecting only causes problems with overload, flickering, etc. With the ESS Assistant it's possible to power your loads from the battery while staying connected to the grid; which allows for the the same, or better, level of self-consumption without nightly disconnects and associated issues.
- Invert priority: This is not possible with ESS. Use the virtual switch instead.
- Connect to AC-input when available: Use ESS Assistant and select one of the two Optimized modes.
- Connect to AC when available, keep batteries charged: Use ESS Assistant and select the “Keep batteries charged” mode.

Make use of 'off-peak tariffs'

Not available in the ESS System yet, but it will be implemented.

Winter mode

The ESS *BatteryLife* feature will make sure that the batteries are not unnecessarily cycled around a low SOC.

See also the *Keep batteries charged* option in the CCGX.

Load shedding

Load shedding is a feature in Hub-2 that is not often used, and therefore not implemented in the ESS Assistant. Instead of sticking to Hub-2 - which we neither recommend nor support - consider using other options.

For example *misuse* the generator start/stop function in CCGX.

Prevent feeding energy back to the grid

The ESS can do this when you have a Fronius inverter. See the [Zero feed-in option](#).

For other brands of PV Inverters use the Hub2 v3 Assistant. Or even better, use an alternative method such as installing MPPT Solar Chargers - leaving *feed-back* enabled ...or install a Fronius PV Inverter.

8.3 Hub-4 Assistant -> ESS Assistant

- Battery capacity is no longer required by the Assistant. Instead enable *battery monitor* and enter the capacity on the General tab in VEConfigure.
- The PV Inverter Assistant is included in the ESS Assistant: it is no longer necessary to add it separately.

(NB. Overload and high temperature bugs are fixed.)

9. FAQ

Q1: Is power from MPPT used to power the loads when feedback is disabled?

Yes. ESS will reduce grid usage to a minimum, preferably to 0W, with or without feed-in enabled. It keeps the MPPT Solar Chargers working hard - even when the batteries are full.

A bit more detail with reference to selected modes:

- In Optimize mode whether the load is great or small power will be supplied by the batteries. The Grid meter will be kept at 0W until either the battery is drained or the load exceeds the inverter's capacity.
- In Keep Batteries charged mode no power comes from the batteries to power loads unless the grid fails. PV power, when available, will be used to power the loads. There is a known issue when using "Keep batteries charged" mode that can result in less production from the MPPT solar charger when batteries are full. This only occurs when [DVCC](#) is disabled, and the "Feed-in excess solar charger power" setting disabled.

The current options to work around this “Keep Batteries charged” issue are:

- Enable **DVCC** (check CCGX manual to see if that is allowed for the used battery type, make & model!)
- Set the mode to Optimize, and set the minimum SOC to 100%. Note that with this workaround there is still a difference with the “Keep batteries charged” mode: the system will not recharge the battery from the grid after a power outage

Q2: I've enabled optimize mode, but do not see grid-power being used to charge the battery?

In optimize mode, ESS will only charge the battery with power coming from PV ...except in two circumstances, both of which are related to battery health, and preventing life-shortening damage:

1. *Sustain*: the battery has been discharged so deeply that the sustain safety mechanism was disabled. [See Chapter 6.4](#)
2. *Slow charge*: *BatteryLife* is enabled, and the system is in Force Charge. [See chapter 4.3.8.](#)

Q3: Even when the battery is full, the system is still connected to AC-in

This question is typically asked by users or installers that are familiar with our previous configurations, for example Hub-1 or Hub-2, in a series installation rather than a grid-parallel installation. In that configuration the system used to switch to inverter mode when the batteries were full-enough.

That was OK, but it also had several disadvantages. An inverter offers a much weaker voltage supply than the public grid does ...and that may lead to:

1. Flickering lights in certain circumstances
2. Inverter shutdown through 'overload' when a large load is switched on

With ESS in Optimize mode the system will always remain connected - even when the batteries are full. And although connected, the power draw is not substantial - this configuration offers the stability of the grid without additional grid consumption.

Q4: Why is the VE.Bus state in pass-through?

In ESS, the conditions for the VE.Bus system to be in *pass-through* (ve.bus state: passthru) are:

1. When the GX device is no longer receiving data from the grid meter. Note that this is only for systems that are configured to have an external grid meter. See the Settings → ESS → Control without grid-meter setting.
2. Systems with a canbus-connected lithium system: when the GX device is no longer receiving information from the battery, via the CAN-bus.
3. When charging the battery is not allowed (BMS max charge current = 0A, or max charge power = 0W) and there is excess PV power.
4. When discharge is not allowed -and- loads on AC-Out force the Multi/Quattro to exceed the AC input current limit. Reasons for not allowing discharge: BMS blocks discharge (DCL=0), or

battery SOC level is below the 'minimum SOC' setting in ESS, when SOC is at least 3% above the set level, discharge is allowed again.

5. A grid code is in use that requires the enabling of battery discharging by aux-inputs. Check the used grid-code in VEConfigure and compare with the electrical signals provided to the Inverter/charger in its AUX inputs.
6. The Loss of Mains detection (LOM) causes issues, often in combination with a high impedance connectivity to the utility. For details see [VEConfigure: grid codes & loss of mains detection](#).

Q5: How can I suppress low battery warnings?

Background: In an off-grid or backup system it makes sense to get a warning when the battery is almost empty. But in a system where the battery is only used to optimize self-consumption, and it's normal to fully deplete the battery every day, it isn't necessary to receive a notification.

- Disabling the Multi's low-battery warning pop-up on the CCGX is achieved by entering the Multi or Quattro *Menu*; selecting *Setup* and then *Alarms*. Set the *Low DC voltage alarm* to *Alarm only*.

The red blinking LED on the inverter/charger - which warns of a low battery - cannot be disabled.

- Suppress email notifications by logging into the VRM Portal, and setting the *Automatic alarm monitoring* to *Only alarms*.

Q6: Optimize mode, no feed-in: The AC Input current fluctuates wildly - sometimes even going negative ...why is this?

This is normal. The current shown is the RMS current. Which does not represent real power, nor real energy being fed into the grid.

Especially around 0 W real power, you'll see that the RMS current is very high. This is caused by the X-capacitors in the Multi.

Look at the Input power readings instead. They fluctuate a lot less, and are a more reliable indication of power and energy.

Q7: How do the charge states work in ESS?

- The MPPTs are always in the `ESS` state. This indicates that the MPPT is being controlled by the Multi or Quattro via the GX device. To view the system state, look at the VE.Bus State.
- While discharging, and connected to the grid, the state can still show a charge state, such as Bulk, Absorption or Float. Even though it is not charging. This is normal, nothing to worry about.
- When in Float, the system will begin a new charge cycle when the battery voltage has been below the restart-voltage for a certain length of time. This voltage depends on the chosen battery type selected on the charger tab in VEConfigure:
 - Lithium: restart-bulk-voltage = Vfloat - 0.2V (max 13.5V)
 - Others: restart-bulk-voltage = Vfloat - 1.3V (max 12.9V)

Note that these charge-cycle restart-mechanisms differ from the stand-alone MPPT Solar Charger algorithm: they restart the charge cycle every day. See the solar charger manuals for more

information about this. (This link takes you to the [Manual Download Page](#)).

Q8: My system switches off in overload - why is this?

Switching off in overload, while connected to the grid, is caused by the active Loss of Mains (LOM) detection, linked to the country code as configured in VEConfigure3.

This behaviour occurs when the AC supplied on the AC-in of the Multi or Quattro is 'weak'. By 'weak' we mean that the AC connection to the utility has a higher impedance than usual. For example a generator, or a house connected with a too-long and/or too-thin cable from the Inverter/Charger to the utility.

For the solution and configuration options, see [VEConfigure: grid codes & loss of mains detection](#).

Q9: Why are my loads powered by the grid instead of battery or solar?

Check list in case loads are being powered from the mains/grid, while expected to be powered from the battery:

First of all, check that the system is not preventing discharge because the battery state of charge is below a limit. See the [Chapter 6 - Controlling depth of discharge](#).

Secondly, in case of a Managed Lithium battery, ie a battery with a CAN-bus connection, check that the battery hasn't disabled discharging: see the battery entry in the Device List menu, and then go to the Parameters submenu and see the Discharge Current Limit (DCL) entry. In case that shows zero, the battery is telling the system to not discharge any further.

Thirdly, feed-in may be disabled because the ESS Relay test is still pending: the inverter/charger (ie Multi/Quattro) in an ESS System needs to perform a relay test before it can use battery power. During the test, it needs to run in inverter mode shortly (~1 minute), and needs enough spare battery capacity to do so. In case the battery voltage is too low while connecting to the grid, the system switches on in pass-through and/or battery charging mode, and, while waiting for the battery to be recharged sufficiently (to do the relay test), it will not feed-in. Meaning that it will not convert DC to AC power, and hence will not power the loads from the battery, and similarly will also not convert any power coming from Solar Chargers to AC: will not power loads with DC-coupled solar power either. And the same: it will not sell excess DC-coupled solar power back to the grid.

The relay test will be performed once either the battery voltage has been recharged above 14/28/56 volt, or when the battery has been recharged to above 20% SOC. To check if a system is in this state, see the ESS Relay test entry in the Advanced submenu of the Multi/Quattro entry in the device list. It will show either Pending, or Completed. Note that that menu entry is only visible for systems with an ESS Assistant installed.

Fourthly, feed-in may be disabled when a grid code (like the German or Australian grid code) uses the aux1 input to disable feed-in, and aux1-in is used by something else (like an AC-sensor or a BMS), this way feed-in can be disabled. Simply un-check the option in the grid-code settings to prevent this.

Lastly, check that the rocker switch on the unit is set to On, rather than to Charger-Only. When set to charger-only, the unit refuses to discharge the battery. Note that to check this, you really need to

physically check the rocker switch: you can't see its state by looking on VRM or on the GX Device. On a MultiPlus-II, this rocker switch is at the bottom of the unit and needs to be in the I position, not on II.

Finally, if all above didn't help - temporarily disable LOM to make sure that is not causing an issue. Details in this document: [VEConfigure: grid codes & loss of mains detection](#).

Q10: Why does the system refuse to discharge my battery?

See Q9.

Q11: My battery is first discharging, and then charged every night?

The recharge you are seeing might be part of the Sustain protection. Consider increasing the minimum SOC level. For example increase it with 5%; and then check what happens.

Or decrease the sustain voltages with VEConfigure, but take proper caution, especially for lead batteries as the sustain levels are designed to prevent early damage to the batteries.

Search this manual for Sustain to learn more.

Q12: What is auto-recharge?

The system will automatically recharge the battery (from the grid) when the SOC drops 5% or more below the value of 'Minimum SOC' in the ESS menu. Recharge stops when it the battery is recharged up to the Minimum SOC level.

Q13: Can I use ESS in a vehicle or a boat?

No, you cannot. After unplugging the shore cord it can take up a moment for the system to detect the loss of mains and open the back-feed relay. During those seconds, the shore power plug will be live: there is 110/230 Volts AC on the terminals. The exact number of seconds differs per country and depends on the local requirements.

The same applies to other solutions where the wiring is not protected against accidental removing, for example a simple cable with end-user removable plug, such as a portable power supply.

10. Troubleshooting

Trouble shooting steps:

1. Start with checking firmware versions (needs to be latest). And when asking questions; report the exact firmware versions that are used.
2. Check battery type/brand. If lead then it might be unsuitable and probably broken because of the heavy cycling.

3. If some unknown or unsupported CANbus battery; change the battery to a supported type.
4. Check the state of the inverter/charger, if its Passthru, then there is an issue. Details are available in Q4 in the previous chapter.

Then; if PV is not used enough to power loads;

1. Check for the # reason codes; see CODE KEY in this manual.
2. Check wiring: lots of voltage drop between MPPT and multi will prevent the system from effectively powering AC loads from solar power.
3. Test with and without SVS enabled: leave it disabled.
4. Next, check MPPT charge current limit during the time that it is not used enough. MPPT CCL is supposed to be high always; even when battery full. Unless there is a temperature issue.
5. Now check MPPT Charge Voltage Setpoint. It is supposed to be above actual battery voltage.

Note that those last two set points are determined by software; and calculated based on the setpoints sent by the (CANbus connected) lithium battery: you can't change them manually. Looking at them however does help understanding why certain things are happening;

DISQUS

~~DISQUS~~

From:
<https://www.victronenergy.com/live/> - **Victron Energy**

Permanent link:
<https://www.victronenergy.com/live/ess:design-installation-manual?rev=1596491835>

Last update: **2020-08-03 23:57**

