

MultiPlus Backup only 5000VA / 24 volt

Introduction

(Explain what it solves:)

A simple system for mains backup.

When mains power is available the loads are powered directly.

If the mains is not available because of load shedding the loads are powered with the energy from the batteries. When the mains is available again the power will be supplied directly from the mains and the batteries will be charged again.

How long is the backup time?

The backup time depends on the power consumption.

If the power consumption is high like during the day then time available will be short. During the night when power consumption is low the time the power can be supplied by the batteries will be longer.

- Load shedding period: High power loads about 1600W DoD 50% SoC about 2 hours runtime
- At night: Low power loads about 400W DoD 50% SoC about 10 hours runtime

Glossary:

SoC: State of charge

DoD: Depth of discharge

Simple system

The basic system consists of only 2 parts:

- MultiPlus
- Batterybank

Connect the AC input to the mains. Connect the AC to the loads you want to backup.

Connect the battery cables to the battery. Read the manual for details on how to safely connect the batteries

Parts

- 1x - PMP243021010 - [MultiPlus 24/3000/70-50 230V VE.Bus Inverter/Charger](#)
- 4x - BAT412201080 - [12V/220Ah AGM Deep Cycle Battery](#)

- or - BAT412201100 - 12V/220Ah Gel Deep Cycle Battery
- 4x - Battery link cables

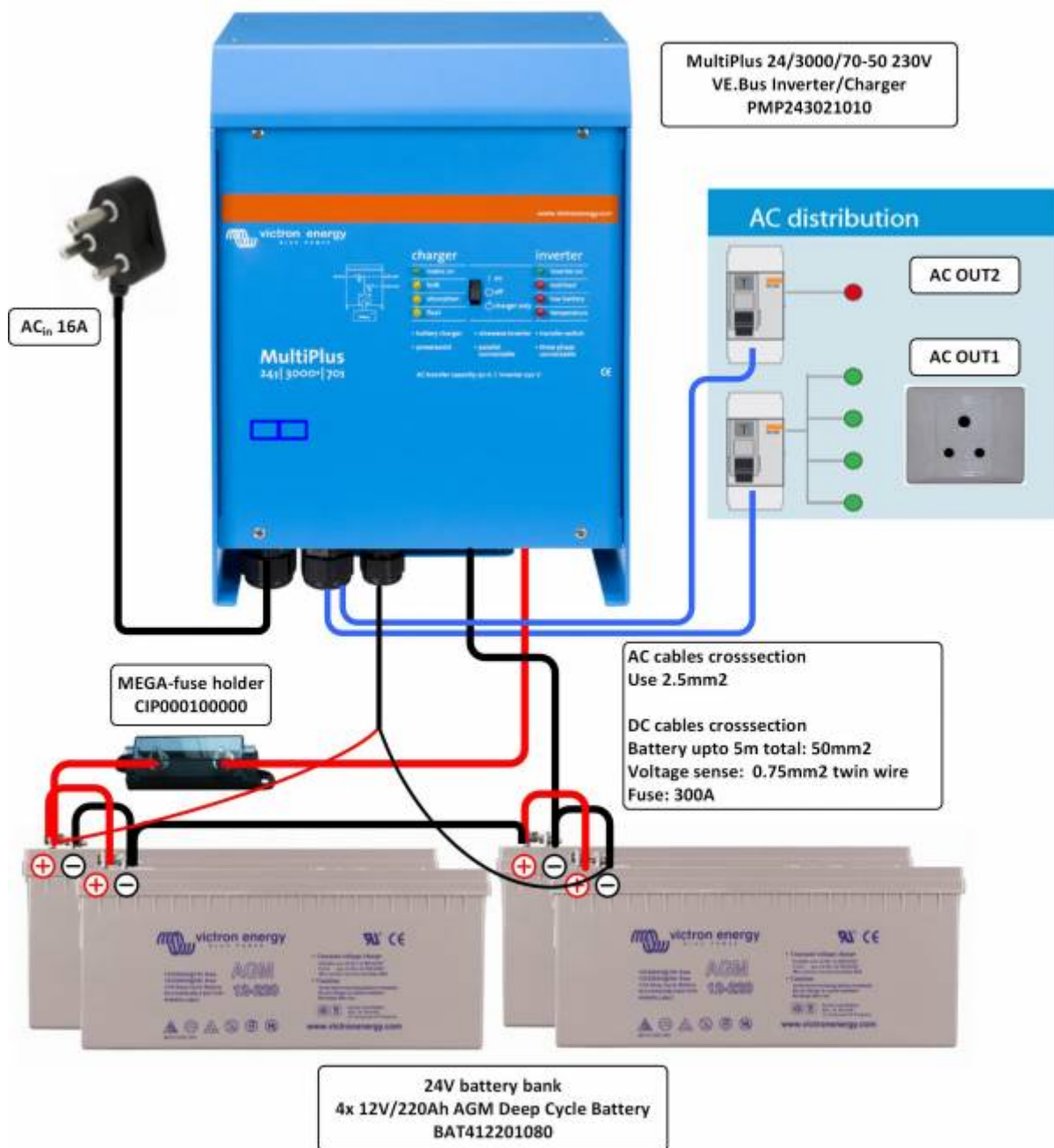

Advanced system

When you want to have a better idea of what your system is doing some optional parts can be installed. For simple monitoring and remote on/off switching the Digital Multi Control can be used. This is installed using 1 network cable. This can be used to turn the Multi on and off and to see the operational state.

If you want to do more advanced monitoring or even logging and remote monitoring you can install the ColorControl GX. This is a graphical display which can connect to almost all Victron equipment and the internet. For more information and details see the product pages.

optional parts

- DMC000200000R - [Digital Multi Control 200/200A GX](#)
- BPP000300100R - [Color Control GX](#)

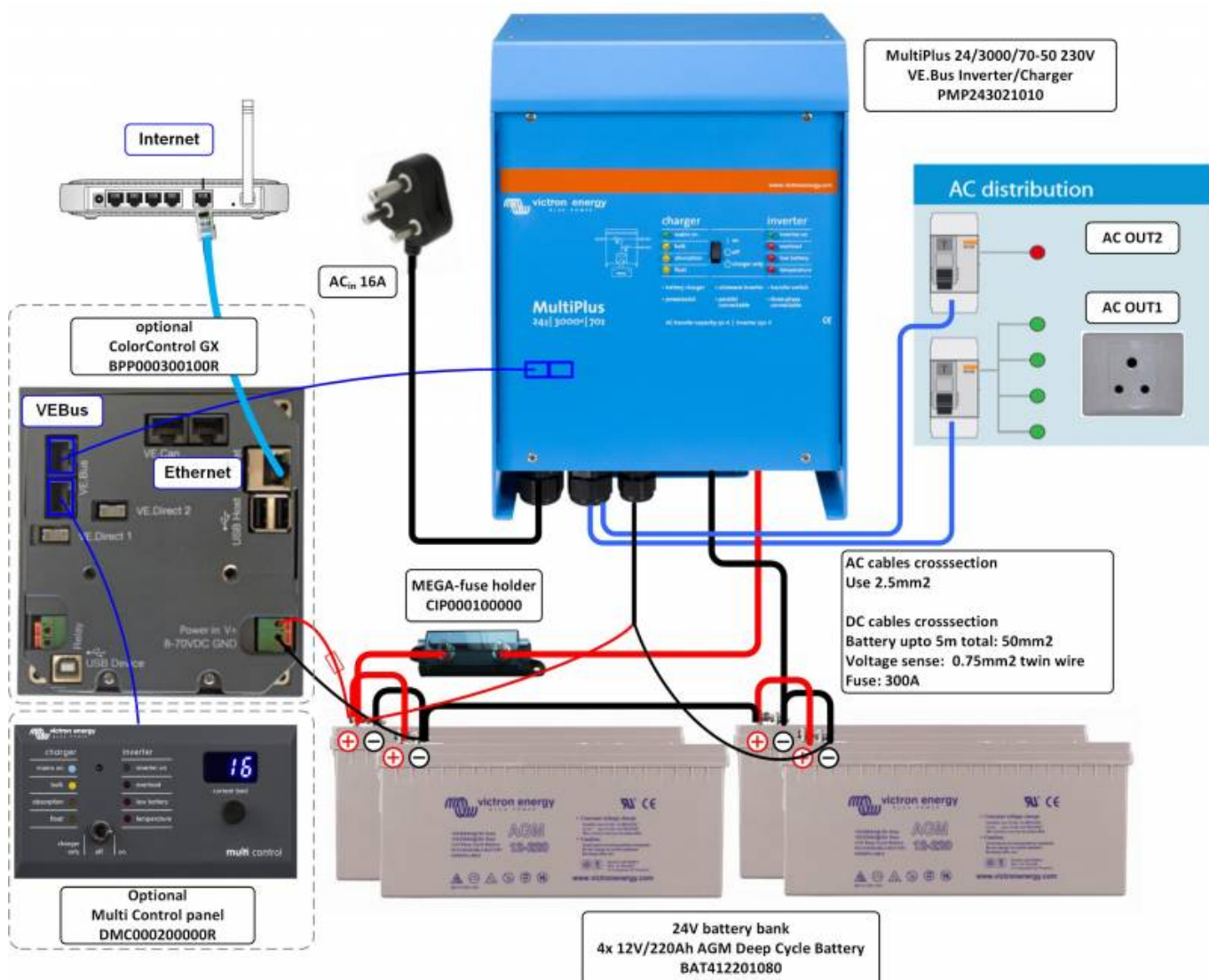

Notes for batteries:

- We recommend using deep-cycle GEL or AGM batteries. At least 200Ah blocks.
- Cable cross section: The Multiplus 1600 comes with battery cables of 1.5m included. These cables are 35mm² thick. If longer cables are needed a cable with a thicker crosssection may be needed. Check the table in this document: [For more information on battery cables](#)

VE.Configure Settings

For the system to work correctly some default settings need to be changed using the program VE.Configure. This can be dowloaded from our website. On our website there is also documentation available that explains how VE.Configure should be used.

- [software download VE.Configure](#)
- [A guide to VEConfigure](#)
- [Updating VE.Bus products](#)

Settings

Only a few settings need to be changed. See the list below. Some screenshots are displayed to help you if you are a first time user.

- Disable overrule by remote → General tab
- Change DC input low shutdown to 10.8 volts → Inverter tab
- Change DC input low restart to 11.8 volts → Inverter tab
- Change DC input low pre-alarm to ???.? volts → Inverter tab
- Charge current can be left at standard setting → Charger tab
- Enable battery monitor and set correct Battery capacity → Battery monitor tab

General tab



Battery monitor tab and Inverter tab

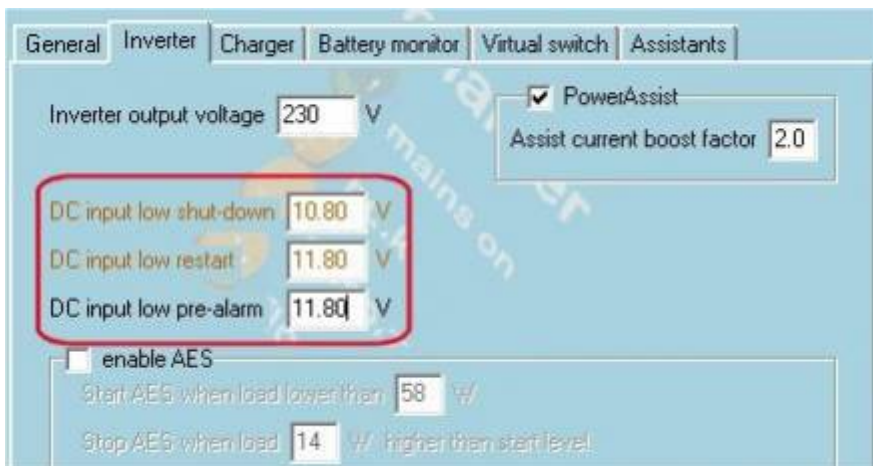

DISQUS Comments

~~DISQUS~~

From: <https://www.victronenergy.com/live/> - **Victron Energy**

Permanent link: https://www.victronenergy.com/live/drafts:sa_system:backup5000?rev=1428916424

Last update: **2015-04-13 11:13**

