

# Victron & LG Chem Resu

## Compatible Victron products

The MultiPlus 48/3000/35. Not multiple in parallel or three-phase.

And always a [Color Control GX](#) is necessary in the system, since that has the canbus port which is used for the (required!) communication between the LG Resu battery and the Victron system.

## Notes

- LG Battery can only be used in a [Victron ESS installation](#) installation that uses the ESS Assistant.
- It can only be used in On-grid systems, for self-consumption. Not for off-grid systems.
- Derating, based on the dynamic LG Resu charge- and discharge limits:
  - Minimum CCGX version is v1.72
  - The derating mechanism is not very precise yet. In other words, do not expect a discharge limit of 30A to result in a precise discharge of 30A.
  - Actual charge- and discharge limits are visible in the Parameters page. See screenshot below.
- LG batteries and MPPT Solar Chargers with a VE.Can communication port cannot be both connected to the CCGX, because of different canbus speeds. Use Solar Chargers with a VE.Direct comm. port instead.
- LG battery policy is to only charge the battery to 97% or 98%. It is normal for the battery not to charge to 100%.

## Color Control GX or Venus GX required

To use the LG Chem Resu and Victron equipment, it is necessary to use a CCGX or VenusGX. It takes care of sending the necessary canbus keep-a-live message to the LG Resu. Without it, the LG Resu will open its internal circuitbreaker after 10 minutes.

## Wiring of communication cables

Use the *VE.Can to CAN-bus BMS type B Cable*, part number ASS030720018. Plug the side which is labeled Battery BMS into the LG Chem Resu BMS. Plug the side labeled Victron VE.Can into the Venus-device.

Then, plug a [VE.Can terminator](#) in the other VE.Can socket on the CCGX. Two VE.Can terminators are included with the package of the CCGX as an accessory, only one is used. Keep the other one as a spare.

More information about the cable can be found in [its manual](#).

Without properly connecting this cable, the battery will stop charging/discharging after several minutes. Also, the battery will not show up on the display of the CCGX.

## Note on the latest LG Resu models (3.3, 6.5 and 10)

Set the SW select switches 3 & 4 on the battery to select the right protocol (LGC Smart).

## VEConfigure settings

### General tab

1. Check "Enable battery monitor"
2. Set the battery capacity to 50Ah times the number of battery modules.
3. Enter the battery capacity:
  1. Resu 6.4 - 126 Ah
  2. Resu 6.4 + 1 pcs EX 3.2 - 189 Ah
  3. Resu 6.4 + 2 pcs EX 3.2 - 252 Ah
  4. Resu 3.3 - 63 Ah
  5. Resu 6.5 - 126 Ah
  6. Resu 10 - 189 Ah
4. The other parameters ("State of charge when bulk finished" and "Charge efficiency") can be left to their default setting. They are not used in this setup.

### Charger tab

Parameter	LG Resu 6.4	LR Resu 3.3, 6.5, 10
Battery type	Lithium	Lithium
Charge curve	Fixed	Fixed
Absorption voltage	56.8 V	57.7 V
Float voltage	56.7 V	57.6 V
Absorption time	1 Hr	1 Hr

Note: make sure to double check the float voltage after completing Assistants.

### Hub-4 Assistant

Select the fourth battery type:

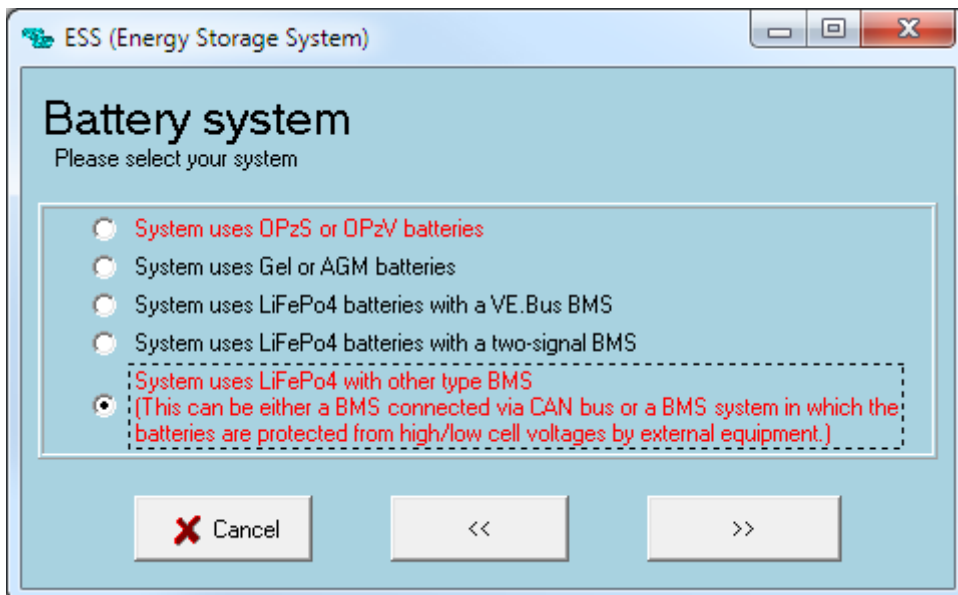

Then:

1. Sustain voltage: 50V
2. Do not change the dynamic cut-off values, they have already been set correctly after selecting the lithium battery type.
3. Same for the restart offset

### Color Control GX Configuration

- Select the *CAN-bus BMS (500 kbits/s)* CAN-profile in the CCGX. Menu path: *Settings* → *Services* → *CAN-profile*. Note that this changes the function of a VE.Can port: it is not possible to connect both VE.Can products and an LG battery together.
- After properly wiring and setting up, the LG Resu will be visible as a battery in the device list:



- The parameters option within the battery page shows the actual battery charge and discharge limits:

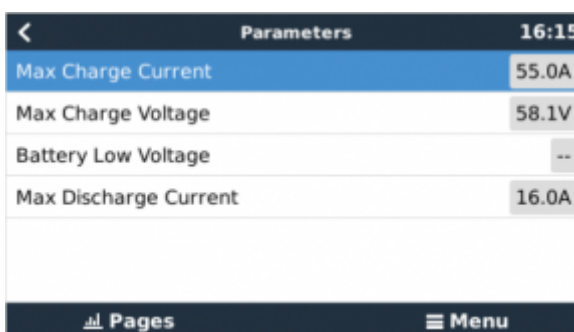

## What to do if the LG Resu 6.4 circuit breaker has tripped?

Starting from version v1.40, the CCGX will detect a tripped LG circuit breaker. If this happens an error will be shown on the display ('Circuit breaker tripped'), both LEDs on the LG resu battery will be off, and the Multis/Quattros will be switched off.

Why would the circuit breaker trip? The only circumstance, apart from faults and broken products, in which the circuit breaker could trip is during a mains failure. During the mains failure the Multis/Quattros will power the AC Loads connected to their output (UPS Loads in above system schematic). And will no longer maintain the discharge current within normal limits, as there is no way for the inverter to reduce the discharge current. Other than completely shutting down of course.

To get the system running again:

1. Ensure on the CCGX that the Multis/Quattros connected to the battery are switched off.



2. Remove the top cover of the battery. The circuit breaker switch should be located between the ON and OFF positions.
3. Move the circuit breaker to the OFF position
4. Move the circuit breaker back to the ON position. If the breaker moves away from the ON position automatically, try again a few seconds later (first to the OFF position then to ON again). If this behavior persists, there may be a battery malfunction.

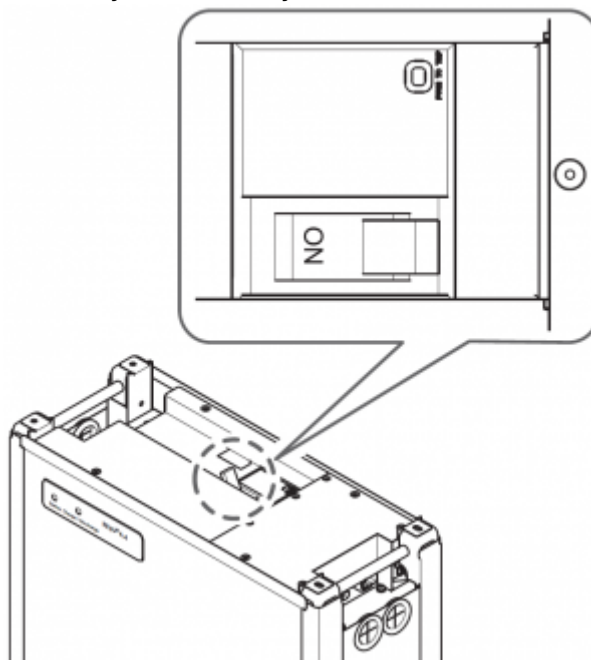

5. Restore the battery top cover again.
6. Switch the Multis/Quattros on in the CCGX menu. Normal operation should continue after the system has initialized.

# DISQUS

~~DISQUS~~

From:  
<https://www.victronenergy.com/live/> - **Victron Energy**

Permanent link:  
[https://www.victronenergy.com/live/battery\\_compatibility:lg\\_chem\\_resu?rev=1523260325](https://www.victronenergy.com/live/battery_compatibility:lg_chem_resu?rev=1523260325)

Last update: **2018-04-09 09:52**

