

Victron & AXIstorage Li 7S / 9S

The combination of Victron products with the BMZ ESS 7.0 battery has been tested and certified by the R&D departments. The combination is actively supported by both companies. The AXIstorage 7S/9S is identical with the BMZ ESS hardware and software and therefore also compatible.

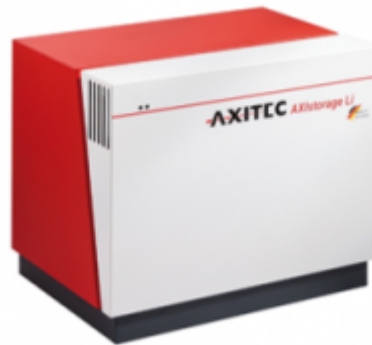

1. Introduction

1.1 Compatible Victron products

All 48V Multis and Quattros. A [Venus-device](#) is necessary in the system, since that has the canbus port which is used for the (required!) communication between the ESS battery and the Victron system.

1.2 Notes

- AXIstorage batteries can only be used in a [Victron ESS installation](#) installation that uses the ESS Assistant.
- Paralleling multiple AXIstorage ESS batteries to expand capacity is possible. Contact AXIstorage for more information.
- Derating, based on the dynamic AXIstorage ESS charge- and discharge limits:
 - Minimum CCGX version is v1.72
 - The derating mechanism is not very precise yet. In other words, do not expect a discharge limit of 30A to result in a precise discharge of 30A.
 - Actual charge- and discharge limits are visible in the Parameters page. See screenshot below in Chapter 5.
- AXIstorage batteries and MPPT Solar Chargers with a VE.Can communication port cannot be both connected to the CCGX, because of different canbus speeds. Use Solar Chargers with a VE.Direct comm. port instead.

1.3 System diagram

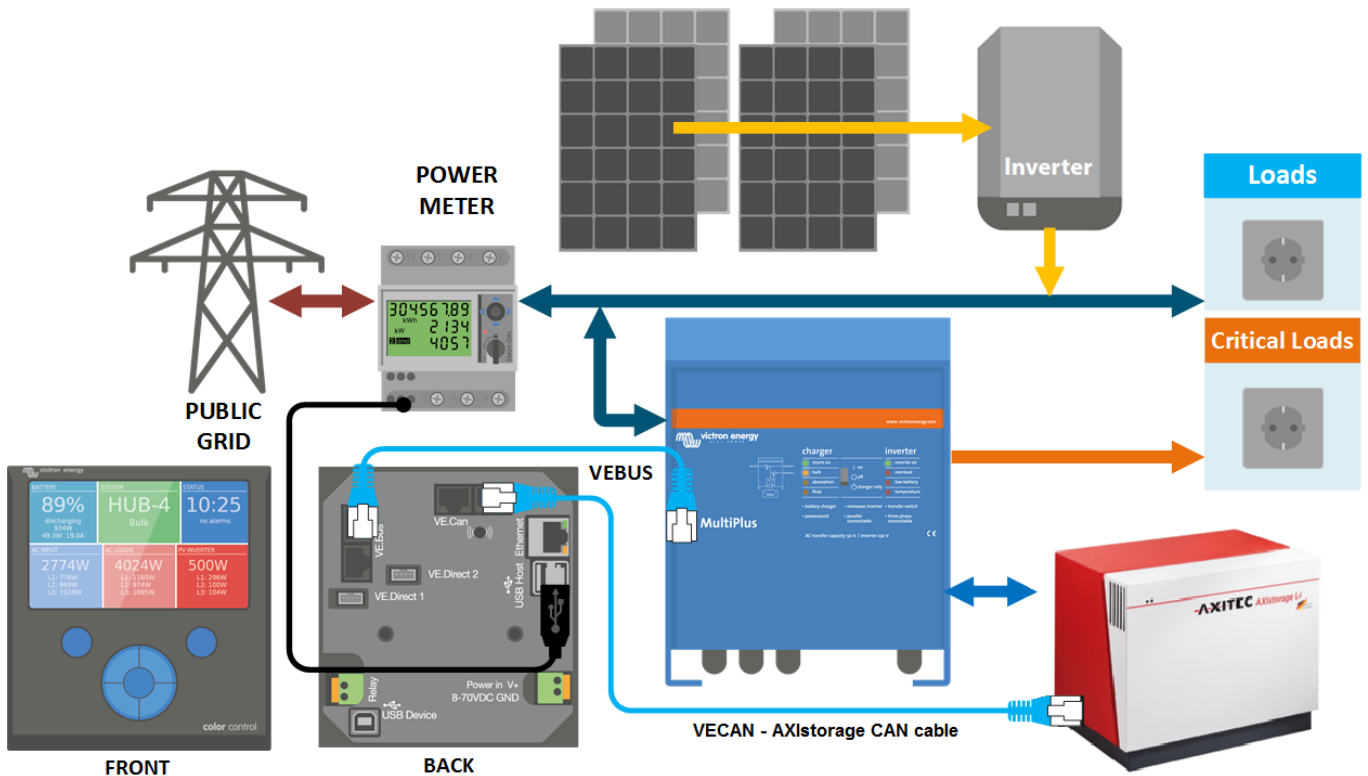

2. Venus-device needed

To use the AXIStorage ESS in Victron system, it is necessary to use a ColorControlGX or a VenusGX. The controller takes care of sending the necessary canbus keep-a-live message to the ESS battery. Without it, the battery will open its internal emergency relay after 10 minutes.

3. Wiring of communication cables

Use the *VE.Can to CAN-bus BMS type B Cable*, part number ASS030720018. Plug the side which is labeled Battery BMS into the AXIStorage BMS. Plug the side labeled Victron VE.Can into the [Venus-device](#).

Then, plug a [VE.Can terminator](#) in the other VE.Can socket on the [Venus-device](#). Two VE.Can terminators are included with the package of the CCGX as an accessory, only one is used. Keep the other one as a spare.

More information about the cable can be found in [its manual](#).

Without properly connecting this cable, the battery will stop charging/discharging after several minutes. Also, the battery will not show up on the display of the of the [Venus-device](#).

4. VEConfigure settings

4.1 General tab

1. Check "Enable battery monitor"

2. Set the battery capacity to 121.5 Ah
3. The other parameters (“State of charge when bulk finished” and “Charge efficiency”) can be left to their default setting. They are not used in this setup.

4.2 Charger tab

Parameter	Setting
Battery type	Lithium
Charge curve	Fixed
Absorption voltage	60.75 V
Float voltage	60.00 V
Absorption time	1 Hr

Note: make sure to double check the float voltage after completing Assistants, and if necessary set it back to 60.00 V.

4.3 ESS Assistant

Select the fourth battery type:

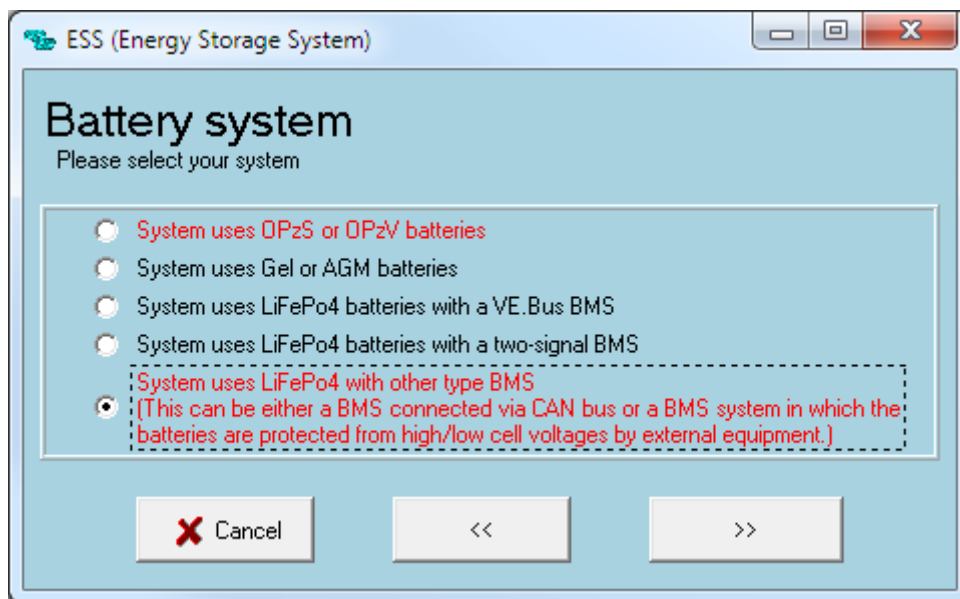

Then:

1. Sustain voltage: 50.0V
2. Do not change the dynamic cut-off values, they have already been set correctly after selecting the lithium battery type.
3. Same for the restart offset: do not change that.

5. Venus-device Configuration

- Select the *CAN-bus BMS (500 kbits/s)* CAN-profile in the *Venus-device*. Menu path: *Settings* → *Services* → *CAN-profile*. Note that this changes the function of a VE.Can port: it is not possible to

connect both VE.Can products and a AXIStorage battery together.

- After properly wiring and setting up, the AXIStorage will be visible as a battery in the device list:

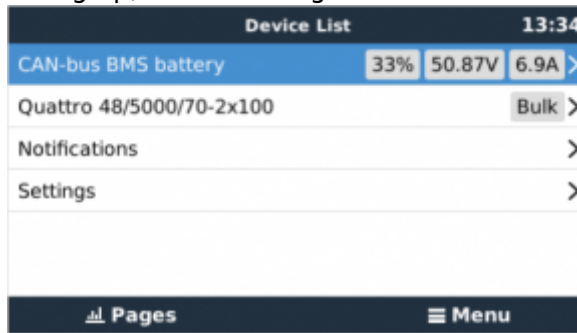

- The parameters option within the battery page shows the actual battery charge and discharge limits:

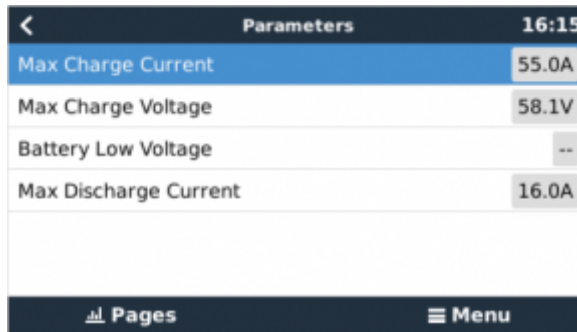

DISQUS

~~DISQUS~~

From: <https://www.victronenergy.com/live/> - **Victron Energy**

Permanent link: https://www.victronenergy.com/live/battery_compatibility:axistorage?rev=1548148578

Last update: **2019-01-22 10:16**

